

# Artefice

*Progetti e manufatti per l'esterno  
in pietra ricostruita*

*Catalogo generale*  
*2018*

## ALCUNE PAROLE SU DI NOI

*Siamo un'azienda a conduzione familiare che da oltre trent'anni crea complementi d'arredo in pietra ricostruita.*

*Ci impegniamo costantemente per garantire la qualità dei nostri prodotti e l'efficienza tecnica.*

*Il cemento è il protagonista delle nostre collezioni d'arredo. La materia prima e la creatività di chi sa metterne a frutto le eccezionali doti danno vita a progetti anche speciali per l'architettura e l'arredo giardino.*

*La conoscenza del materiale e delle sue peculiarità, unita all'esperienza acquisita, ci permette di non avere limitazioni nella realizzazione dei progetti.*

# Catalogo generale

2018

<u>Collezione Fontane</u>	<u>pag. 1</u>	<u>Collezione Pozzi</u>	<u>pag. 17</u>
<u>Collezione Fontanelle</u>	<u>pag. 23</u>	<u>Collezione Lavelli</u>	<u>pag. 26</u>
<u>Collezione Statue</u>	<u>pag. 29</u>	<u>Collezione Nicchie</u>	<u>pag. 36</u>
<u>Forni e Barbecue</u>	<u>pag. 37</u>	<u>Collezione Comignoli</u>	<u>pag. 41</u>
<u>Collezione Ornie</u>	<u>pag. 43</u>	<u>Collezione Modanature</u>	<u>pag. 47</u>
<u>Collezione Coprimuri</u>	<u>pag. 49</u>	<u>Collezione Balaustre</u>	<u>pag. 51</u>
<u>Collezione Recinzioni</u>	<u>pag. 55</u>	<u>Pilastrini e colonne</u>	<u>pag. 57</u>
<u>Collezione Rivestimenti</u>	<u>pag. 69</u>	<u>Aiuole e Passi</u>	<u>pag. 71</u>
<u>Panche e tavoli</u>	<u>pag. 73</u>	<u>Capitelli e Consolle</u>	<u>pag. 78</u>
<u>Collezione Bassorilievi</u>	<u>pag. 80</u>	<u>Collezione Terminali</u>	<u>pag. 83</u>
<u>Collezione Lanterne</u>	<u>pag. 84</u>	<u>Collezione Fioriere</u>	<u>pag. 87</u>

Artefice

Collezione Fontane



**FON-01 FONTANA PALMA D'ORO**

 Vasca ø cm 153, h cm 170

 kg 520

 8 componenti, impianto con 25 getti, 4 faretti

Artefice



### FON-02 FONTANA GALATEA

 Vasca ø cm 153, h cm 220

 kg 760

 8 componenti, impianto con 25 getti + 2 getti centrali, 3 faretti

Collezione Fontane



**FON-03 FONTANA SALICE**

 Vasca ø cm 140, h cm 90

 kg 140

 5 componenti, impianto con 23 getti + 1 centrale, 3 faretti

## FON-04 FONTANA VELI

 Vasca ø cm 140, h cm 190

 kg 480

 7 componenti,  
impianto con 23 getti, 3 faretti



## FON-05 FONTANA BAGNANTE

 Vasca ø cm 140, h cm 155

 kg 480

 7 componenti,  
impianto con 23 getti  
+ 1 getto centrale, 3 faretti

Artefice

Collezione Fontane



**FON-06 FONTANA PERLA**

 Vasca ø cm 200, b cm 220, h cm 265

 kg 1400

 17 componenti, impianto con 31 getti  
+ 2 getti centrali, 3 faretti





# Artefice



## FON-07 FONTANA NINFA

 Vasca ø cm 200, h cm 270

 kg 1350

 14 componenti, impianto con 31 getti + 2 getti centrali, 3 faretti

Collezione Fontane



### FON-08 FONTANA FANCIULLI

 Vasca ø cm 200, h cm 190

 kg 800

 9 componenti,  
impianto con 31 getti  
+ 2 getti centrali, 5 faretti

### FON-09 FONTANA BRAMANTE

 Vasca ø cm 200, b cm 300, h cm 260

 kg 1350

 17 componenti,  
impianto con 31 getti  
+ 1 getto centrale, 7 faretti





Artefice



### FON-10 FONTANA CASTELLO

 Vasca ø cm 280, b cm 380, h cm 130

 kg 2800

 18 componenti, impianto con 48 getti + 1 getto centrale, 4 faretti

 Vasca da completare in loco, disponibile in diverse composizioni e misure

Collezione Fontane

Artefice

Collezione Fontane



### FON-11 FONTANA SIRENETTE

 Vasca ø cm 240, b cm 340, h cm 230

 kg 3400

 40 componenti, impianto con 3 getti centrali + 15 getti, 3 faretti

 Vasca da completare in loco, disponibile in diverse composizioni e misure

Artefice



Collezione Fontane

### FON-12 FONTANA MIAMI



Vasca ø cm 200, b cm 280, h cm 60



kg 3000



31 componenti, impianto con doppia corona di ugelli + 1 getto centrale, 4 faretti





Vasca da completare in loco, disponibile in diverse composizioni e misure



**FON-13 FONTANA NILO**

 Vasca ø cm 205, h cm 55

 kg 2000

 9 componenti, impianto con 5 getti, 4 faretti

Artefice



Collezione Fontane

### FON-14 FONTANA MURALE

 Vasca ø cm 200, h cm 190

 kg 2300

 8 componenti, impianto con cascata d'acqua, 3 faretti



**FON-15 FONTANA BOTTICELLA**

▮▮▮ ø cm 75, h cm 110

▮ kg 165

▮ 4 componenti, impianto con un getto



**FON-16 FONTANA CASCATINA**

▮▮▮ ø cm 110, h cm 150

▮ kg 180

▮ 8 componenti, impianto con un getto



### FON-17 FONTANA ANATRA

 ø cm 55, h cm 90

 kg 180

 1 componenti, impianto con un getto



### FON-18 BASE FLOREALE

 ø cm 55, h cm 50

 kg 80



### FON-19 ANFORA

 cm 65x35, h cm 40

 kg 50



FON-20 FONTANA PUTTO

▮▮▮ ø cm 48, h cm 60

👤 kg 48

🧩 2 componenti, impianto con un getto

FON-21 FONTANA PALMETTA

▮▮▮ ø cm 48, h cm 60

👤 kg 50

🧩 2 componenti, impianto con un getto



### Kit idro-elettrico

- ① Tubo troppopieno
- ② Filtro d'aspirazione
- ③ Ugelli in ottone
- ④ Corona di ugelli
- ⑤ Faretto subacqueo
- ⑥ Raccorderia idrica
- ⑦ Trasformatore
- ⑧ Pompa d'acqua

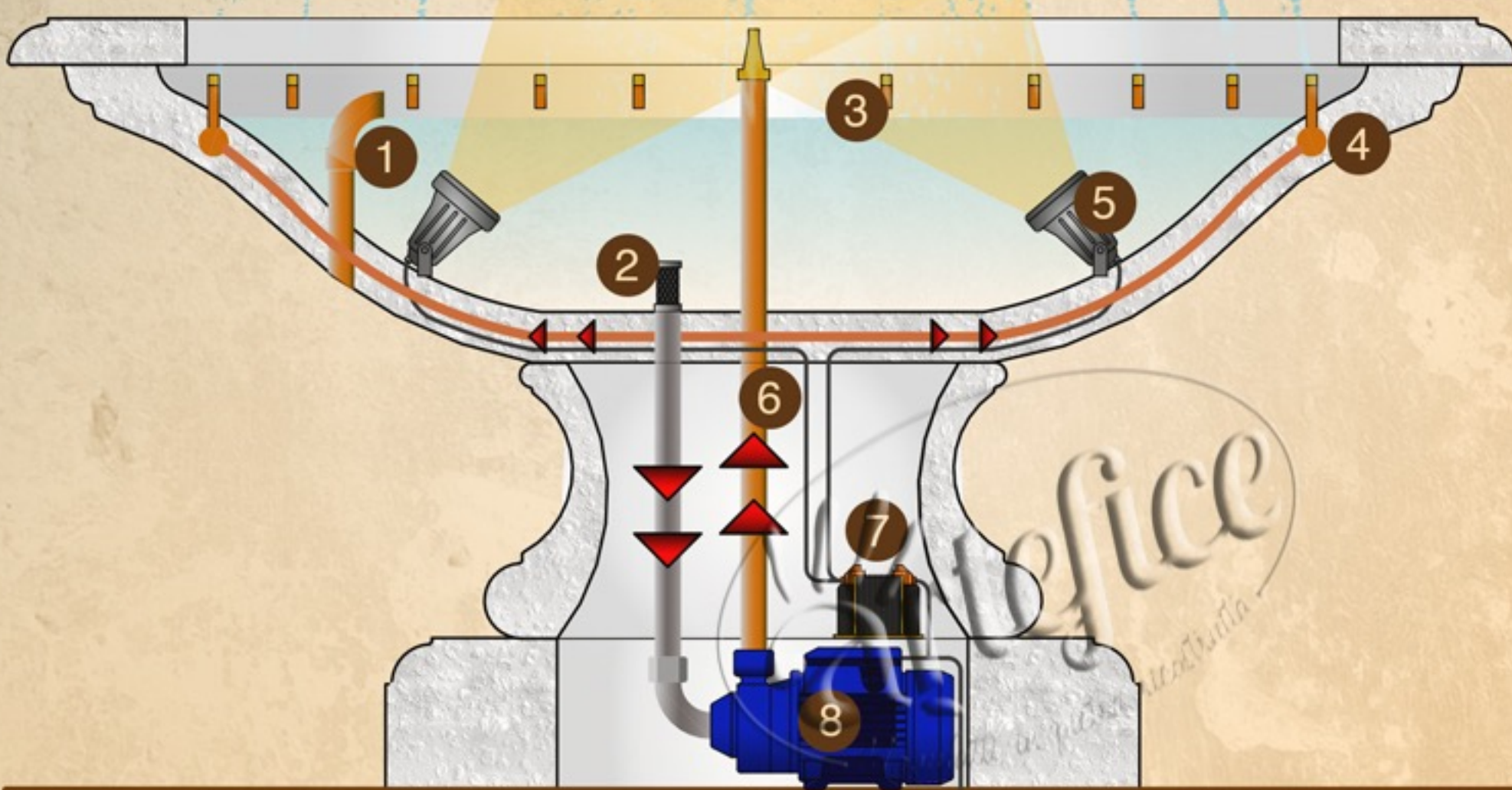

### Kit per fontane a riciclo d'acqua

Il kit fornito con le nostre fontane è indispensabile per renderle funzionanti e luminose. Le fontane sono concepite per l'esterno, e funzionano con l'ausilio della pompa a circuito chiuso, quindi non necessitano di collegamento idrico. Sia il circuito idrico, sia quello elettrico sono integrati all'interno della vasca, non lasciando a vista antiestetici fili e tubature, e garantendo maggiore sicurezza e una più facile pulizia.

**Montaggio:** Montare sempre la fontana su basi solide e ben livellate. Dopo aver posizionato la base della fontana, appoggiare la vasca. Qualora si verificassero piccole imperfezioni, queste possono essere corrette con cunei di materiale rigido (legno o plastica), a condizione che non pregiudichino la stabilità. Controllare che la vasca sia centrata e livellata.

Gli articoli FON-10, FON-11, FON-12, disponibili in diverse composizioni e dimensioni, sono composti da elementi prefabbricati che devono essere montati in loco, al cui interno va poi creata la vasca in cemento.

**Importante:** La pompa non deve funzionare senz'acqua. Per un corretto funzionamento i faretti devono essere collegati al trasformatore e sommersi dall'acqua.

Mantenere pulito il filtro d'aspirazione, eventuali ostruzioni potrebbero impedire all'acqua di arrivare alla pompa e determinare getti d'acqua a intermittenza.

Durante il funzionamento l'acqua potrebbe spruzzare all'esterno delle vasche a causa di agenti esterni quale il vento. Durante il periodo invernale, quando le fontane non sono in funzione, si raccomanda di svuotare dall'acqua tutte le parti delle fontane (corona di ugelli, tubazioni, vasche e pompa).



**POZ-01 POZZO RURALE**



Base ø cm 110, h cm 96



kg 450



5 componenti



Disponibile anche con impianto per cascata d'acqua, un faretto



**POZ-02 POZZO ANTICO**



Base ø cm 120, h cm 90



kg 380



5 componenti



Disponibile anche con impianto per cascata d'acqua, un faretto

### POZ-03 POZZO FIORENTINO GRANDE

 Base ø cm 158, int. anello ø cm 85, h cm 90

 kg 480

 9 componenti

 Disponibile anche con impianto per cascata d'acqua, un faretto



### POZ-04 POZZO FIORENTINO PICCOLO

 Base ø cm 132, int. anello ø cm 62, h cm 82

 kg 270

 9 componenti

 Disponibile anche con impianto per cascata d'acqua, un faretto



### POZ-05 POZZO UMBRO

 Base ø cm 90, int. anello ø cm 62, h cm 90

 kg 220

 4 componenti

 Disponibile anche con impianto per cascata d'acqua, un faretto



### POZ-06 POZZO MATTONI

 Base ø cm 90, int. anello ø cm 62, h cm 90

 kg 220

 4 componenti

 Disponibile anche con impianto per cascata d'acqua, un faretto



### POZ-07 POZZO ESAGONALE

 Base ø cm 130, h cm 90

 kg 310

 4 componenti

 Disponibile anche con impianto per cascata d'acqua, un faretto

Collezione Pozzi



### POZ-08 POZZO MEDIOEVO

 Base ø cm 130, h cm 85

 kg 300

 3 componenti





### Kit idro-elettrico

- 1 Ferro ornamentale
- 2 Secchiello
- 3 Coperchio
- 4 Tubo troppopieno
- 5 Raccorderia idrica
- 6 Faretto subacqueo
- 7 Anello-vasca
- 8 Pompa subacquea
- 9 Basamento
- 10 Trasformatore
- 11 Gradino



Collezione Pozzi

### Pozzo-Fontana

I pozzi presenti in catalogo sono utilizzati come copertura e protezione di cisterne e pozzi artesiani, e facilitano la loro ispezione tramite l'apertura sul fondo. A richiesta tutti i pozzi possono essere forniti con impianto, divenendo una fontana con cascata d'acqua.

#### Montaggio:

Montare il pozzo su piani d'appoggio solidi e ben livellati.

Dopo aver posizionato i gradini e la base del pozzo, appoggiare l'anello-vasca e il coperchio.

Il ferro ornamentale permette l'afflusso d'acqua dalla pompa sommersa al secchiello, che alimenta il pozzo con una cascata d'acqua.

#### Importante:

La pompa non deve mai funzionare senz'acqua.

Per un corretto funzionamento i faretto devono essere collegati al trasformatore e sommersi dall'acqua. Durante il periodo invernale, si raccomanda di svuotare dall'acqua l'anello-vasca, tubazioni e pompa.

FEL-01 FONTANA PIETRA

cm 55x55, h cm 95

kg 80



FEL-02 FONTANA TRANI

cm 47x45, h cm 100

kg 112



FEL-03 FONTANA LAVICA

cm 60x90, h cm 103

kg 205

4 componenti





### FEL-04 FONTANA DOLOMITE

 cm 75x55, h cm 120

 kg 225

 3 componenti



### FEL-05 FONTANA GELSOMINO

 cm 75x57, h cm 135

 kg 250

 3 componenti



### FEL-06 FONTANA TRONCO

 cm 52x52, h cm 98

 kg 80

*Collezione Fontanelle*



FEL-07 FONTANA PEGASO

cm 100x50, h cm 120

kg 218

2 componenti

FEL-08 FONTANA DELFINI

cm 42x34, h cm 98

kg 50



FEL-09 FONTANA ANGOLO

cm 45x45, h cm 130

kg 115

2 componenti



**LAV-01 LAVELLO BIVASCA**

 cm 96x53, h cm 120

 kg 210

 4 componenti



**LAV-02 LAVELLO CON RIPIANO**

 cm 120x53, h cm 90

 kg 200

 3 componenti



LAV-03 LAVABO A COLONNA

 cm 66x46, h cm 140

 kg 120

 3 componenti



LAV-04 LAVELLO SOLE

 cm 100x50, h cm 125

 kg 248

 4 componenti

Artefice



**LAV-05 LAVATOIO 60**

 cm 60, h cm 80

 kg 110

**LAV-06 LAVATOIO 80**

 cm 80, h cm 80

 kg 135



**LAV-07 LAVATOIO 100**

 cm 100, h cm 80

 kg 170

Collezione Lavelli

**STA-01 STATUA NINFA**

 cm 50 x 50, h cm 140

 kg 230



**BAE-02 BASE FESTONE**

 cm 60 x 60, h cm 60

 kg 200

*Collezione Statue*



**BAE-03 BASE CON CORONA**

 cm 58 x 58, h cm 74

 kg 110



**STA-04 STATUA PERLA**

 ø cm 44, h cm 120

 kg 165



Artefice



STA-05 VENERE PUDICA

cm 36 x 36, h cm 120

kg 80

Artefice



STA-06 BAGNANTE

cm 40 x 40, h cm 90

kg 80

Collezione Statue

**STA-07 NUDO CON FIORI**

cm 30 x 30, h cm 120

kg 83



**STA-08 NUDO CON DRAPPO**

cm 30 x 30, h cm 120

kg 86



**BAE-09 BASE LEONE**

cm 33 x 33, h cm 53

kg 55

**STA-10 CONTADINO**

h cm 83

kg 36

**STA-11 CONTADINA**

h cm 83

kg 36



**STA-12 AMORINO CON VASO**

ø cm 40, h cm 90

kg 65

**STA-13 PUTTO AMORINO**

ø cm 30, h cm 72

kg 40



**STA-14 MUSA**

h cm 80

kg 25



STA-15 PUTTO ANATRA

||| ø cm 20, h cm 64

🗿 kg 18



STA-16 PUTTO PESCE

||| ø cm 160, h cm 50

🗿 kg 20



STA-17 PUTTO SORGENTE

||| ø cm 22, h cm 58

🗿 kg 30



STA-18 PUTTO BOTTE

||| ø cm 18, h cm 50

🗿 kg 18



**ANM-19 AQUILA MARINA DX**

 cm 20 x 20, h cm 48

 kg 20



**ANM-20 AQUILA MARINA SX**

 cm 20 x 20, h cm 48

 kg 20



**ANM-21 PESCE**

 ø cm 18, h cm 50

 kg 16



**ANM-22 AQUILA REALE**

 cm 35 x 35, h cm 92

 kg 60



BUS-24 BIMBA

cm 20x25, h cm 40

kg 26



BUS-23 VENTO

cm 20x20, h cm 35

kg 20



BUS-25 GIOVANNI XXIII

cm 10x10, h cm 26

kg 6

BUS-26 PADRE PIO

cm 18x18, h cm 32

kg 14



### NIC-01 NICCHIA CONCHIGLIA

 cm 50x30, h cm 120

 kg 100

 2 componenti (Madonna esclusa)



### NIC-02 NICCHIA RUSTICA

 cm 30x65, h cm 142

 kg 128

 2 componenti (Madonna esclusa)



**FOR-01 BARBECUE STROMBOLI**

 cm 105x60, h cm 230

 kg 450

 9 componenti





Artefice



Collezione Forni e Barbecue

**FOR-02 FORNO MEDITERRANEO**

 cm 180x140, h cm 235

 kg 2800

 22 componenti

### FOR-03 FORNO VESUVIO

 cm 111x112, h cm 50

 kg 315

 1 piano + 4 spicchi

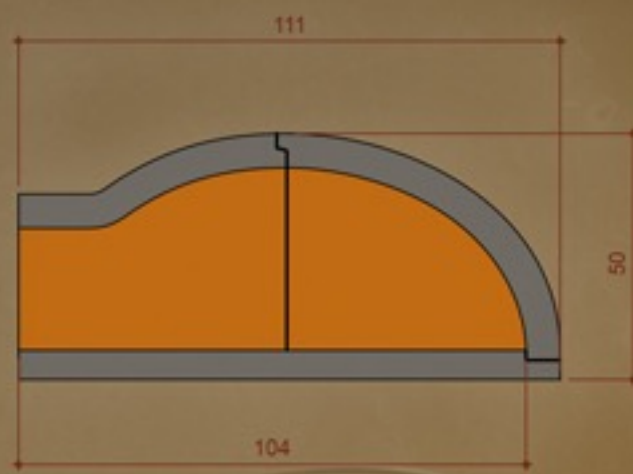
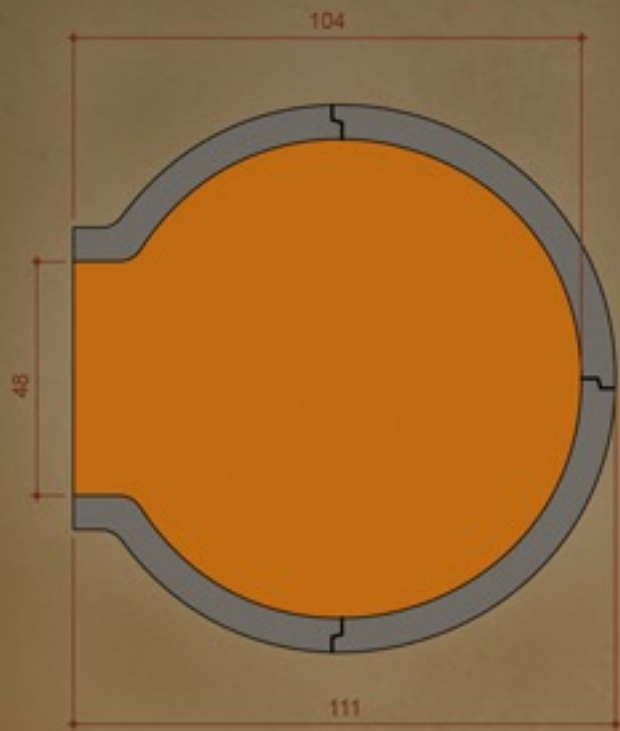

### FOR-04 FORNO ETNA

 cm 141x112, h cm 50

 kg 420

 3 piani + 6 spicchi

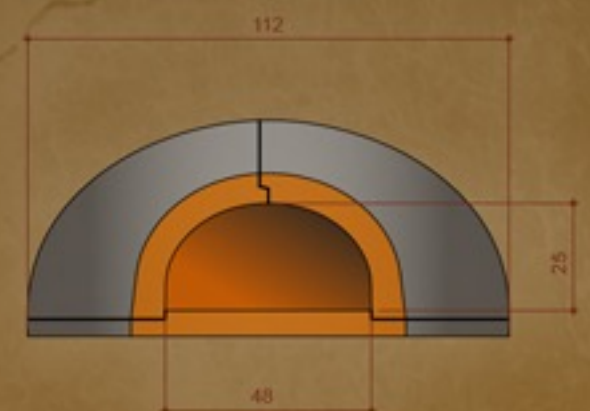
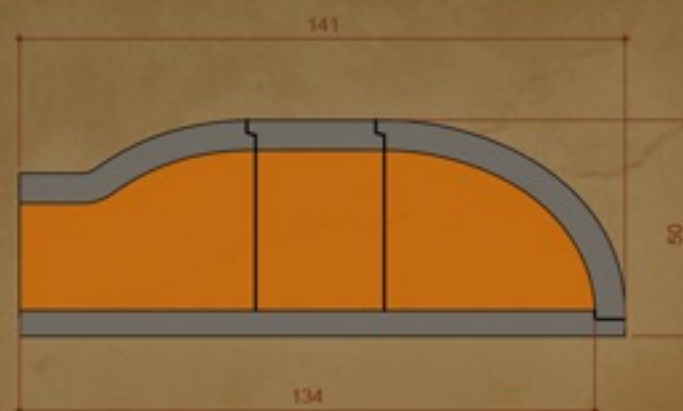
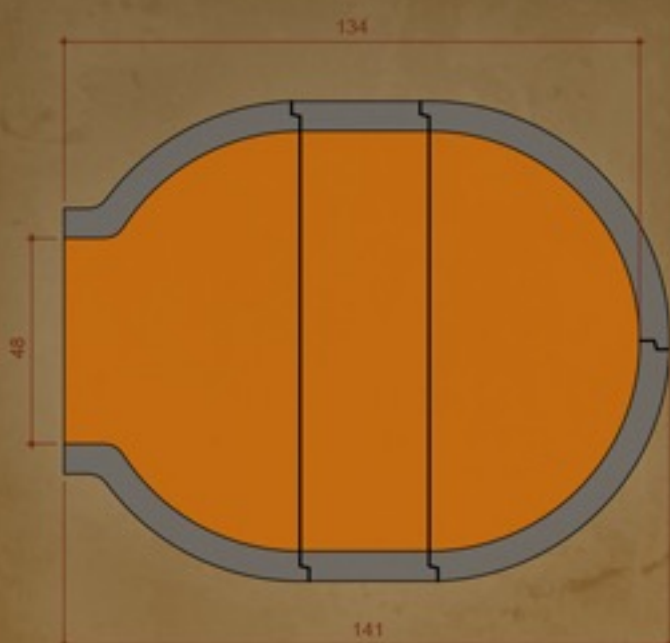

## Scheda Forno

Il forno é costituito da vari elementi componibili, facili e veloci da montare. Lo si può riscaldare con qualsiasi tipo di legna, fino a quando la volta interna diventa bianca, segnale che il forno ha raggiunto la temperatura di cottura. A questo punto si pulisce il piano dalla brace e si infornano gli alimenti. Il forno VESUVIO può contenere 5 pizze e 10 Kg di pane. Il forno ETNA contiene 7 pizze e 14 Kg di pane.

### Montaggio:

Sul piano predisposto si posizionano i blocchi isolanti (tufo o siporex) ben livellati e materassino in lana ceramica. Su questa base si posiziona il piano cottura su cui poggeranno i quattro spicchi della volta. Si montano gli spicchi facendo attenzione a far combaciare le mascherature secondo lo schema. I giunti esterni della volta vanno stuccati con malta refrattaria. Il forno va coibentato con materassino di lana ceramica e ricoperto da argilla espansa, il tutto va protetto dalla pioggia. Dopo aver montato e ben isolato il forno, è particolarmente importante la prima accensione. Accendere il forno non prima di 4 giorni dalla conclusione del montaggio per permettere alle parti in muratura di consolidarsi e alla malta di fare presa. Riscaldare il forno per circa un'ora con carbone di legna. Tale operazione va ripetuta nei giorni successivi aumentando in maniera costante la temperatura ed i tempi d'accensione, fino a completa eliminazione dell'umidità residua. Portare il forno a temperatura d'esercizio mediante un'accensione graduale spostando periodicamente le braci da un lato all'altro del piano di cottura. Ripetere tali procedure dopo un lungo periodo d'inattività del forno. Occorre sottolineare che eventuali venature o piccole crepe sono una caratteristica dei materiali sottoposti a sollecitazioni termiche e non pregiudicano in alcun modo il corretto funzionamento e le prestazioni, in quanto caratteristica intrinseca del forno a legna.



### Schema forno

- ① Piano base
- ② Spicchio anteriore destro
- ③ Spicchio anteriore sinistro
- ④ Spicchio posteriore destro
- ⑤ Spicchio posteriore sinistro



COM-01 COMIGNOLO LISTELLO

 b cm 35x35, h cm 64

 kg 110

 2 componenti

COM-02 COMIGNOLO PAGODA

 b cm 35x35, h cm 65

 kg 80

 2 componenti

Artefice

COM-03 COMIGNOLO ARCHETTI

 b cm 35x35, h cm 64

 kg 110

 2 componenti



COM-04 COMIGNOLO MATTONE

 b cm 43x43, h cm 55

 kg 110

 2 componenti

Collezione Comignoli

Collezione Ornice



ORN-01



ORN-02



ORN-03



ORN-04



ORN-05



ORN-06



ORN-07



ORN-08



ORN-09



ORN-10





ORN-11



ORN-12



ORN-13



ORN-14



ORN-15



ORN-16



ORN-17



ORN-18



ORN-19



ORN-20



*Collezione Ornici*

Collezione Ornice

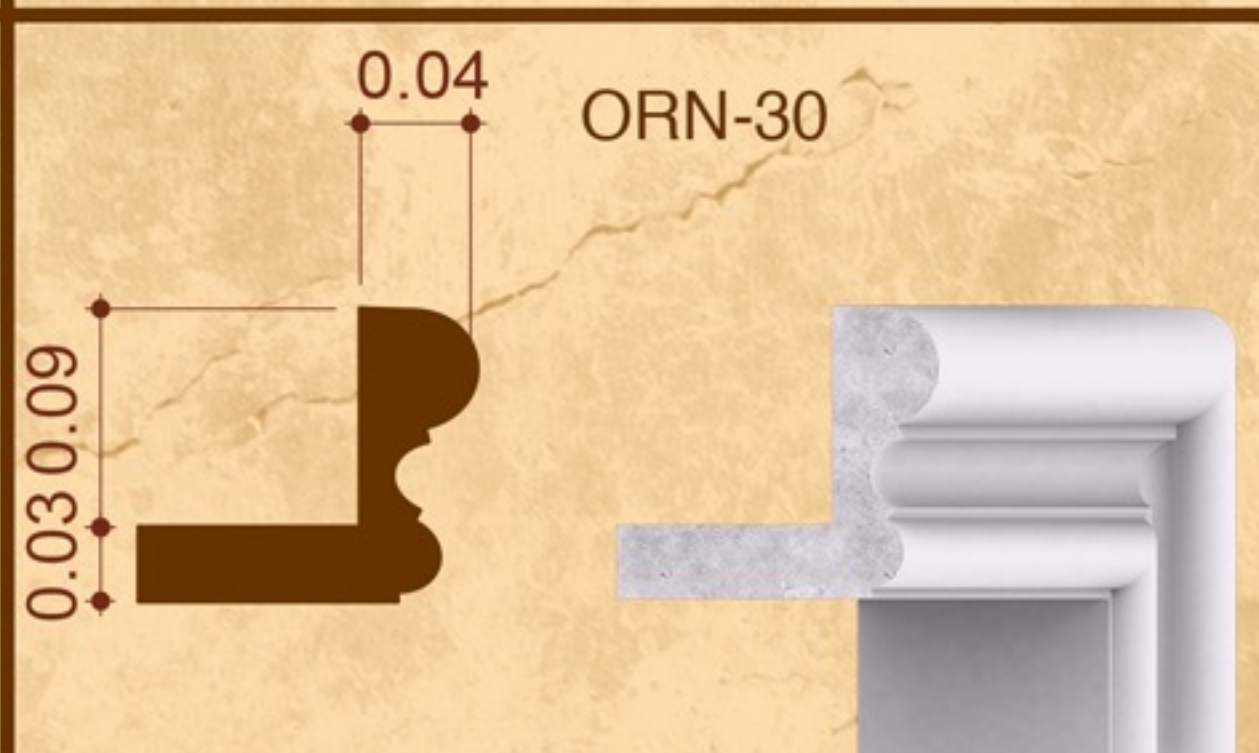
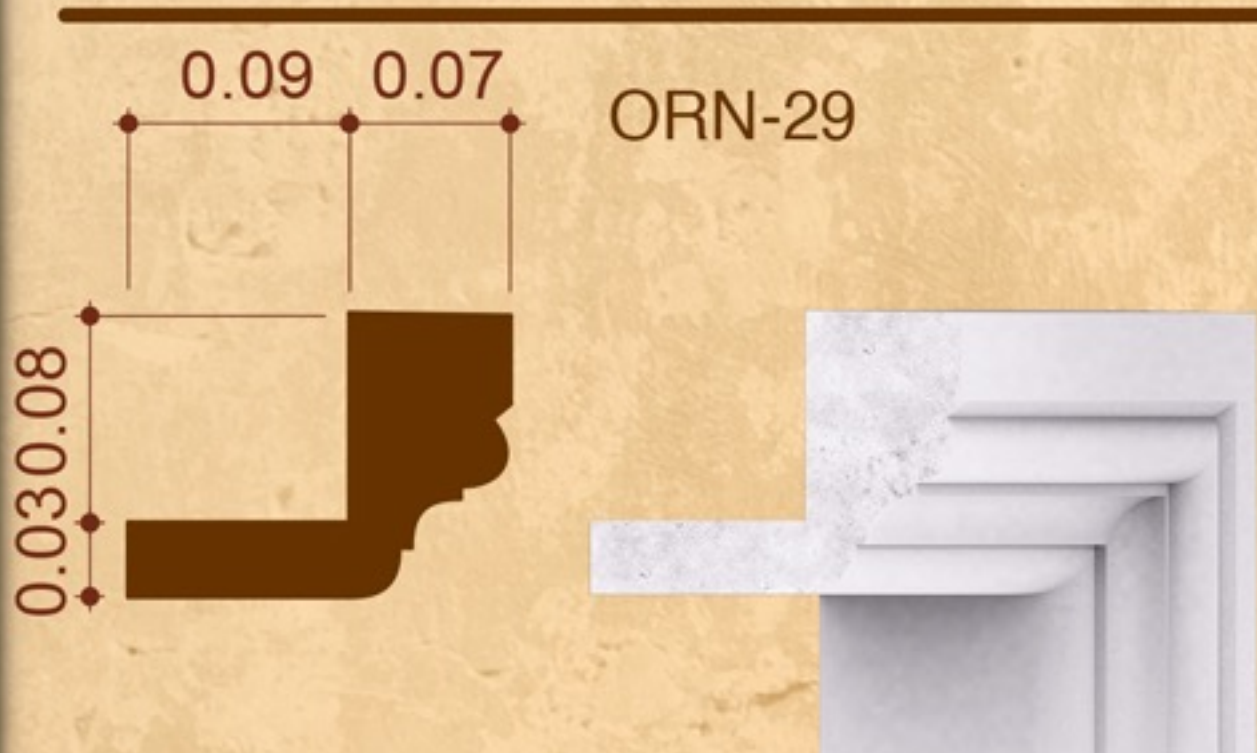
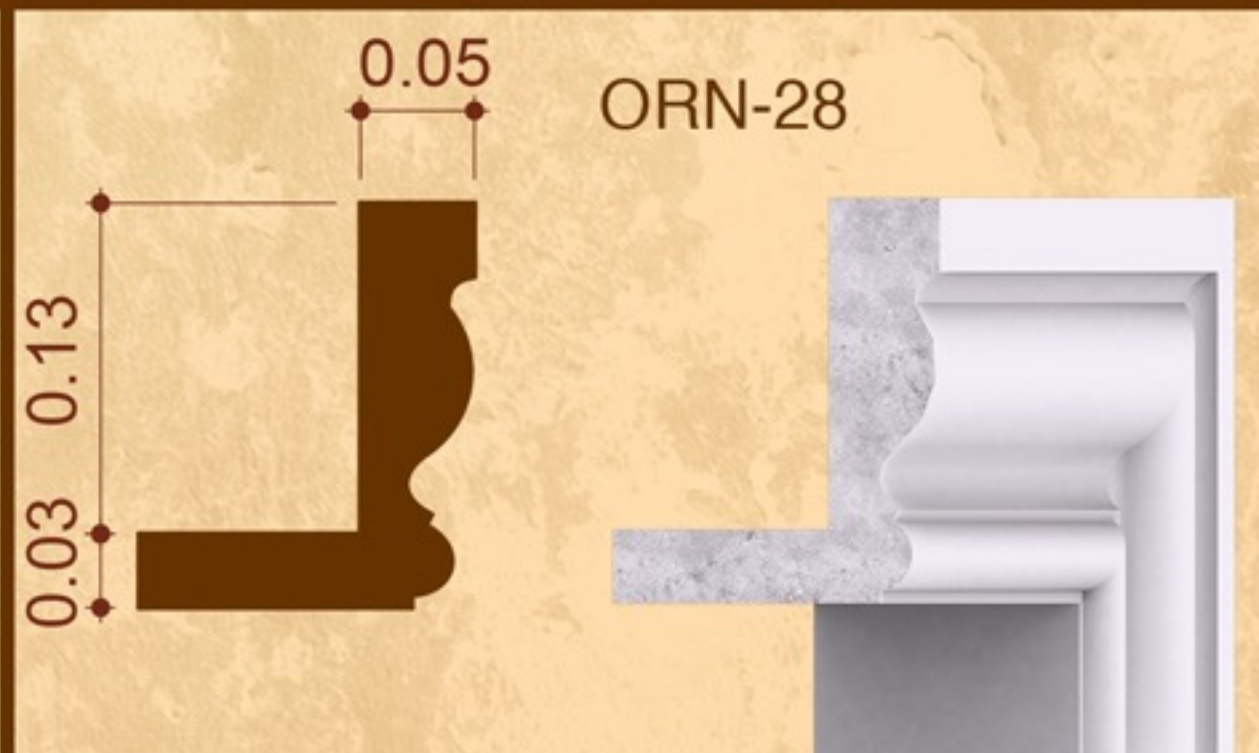
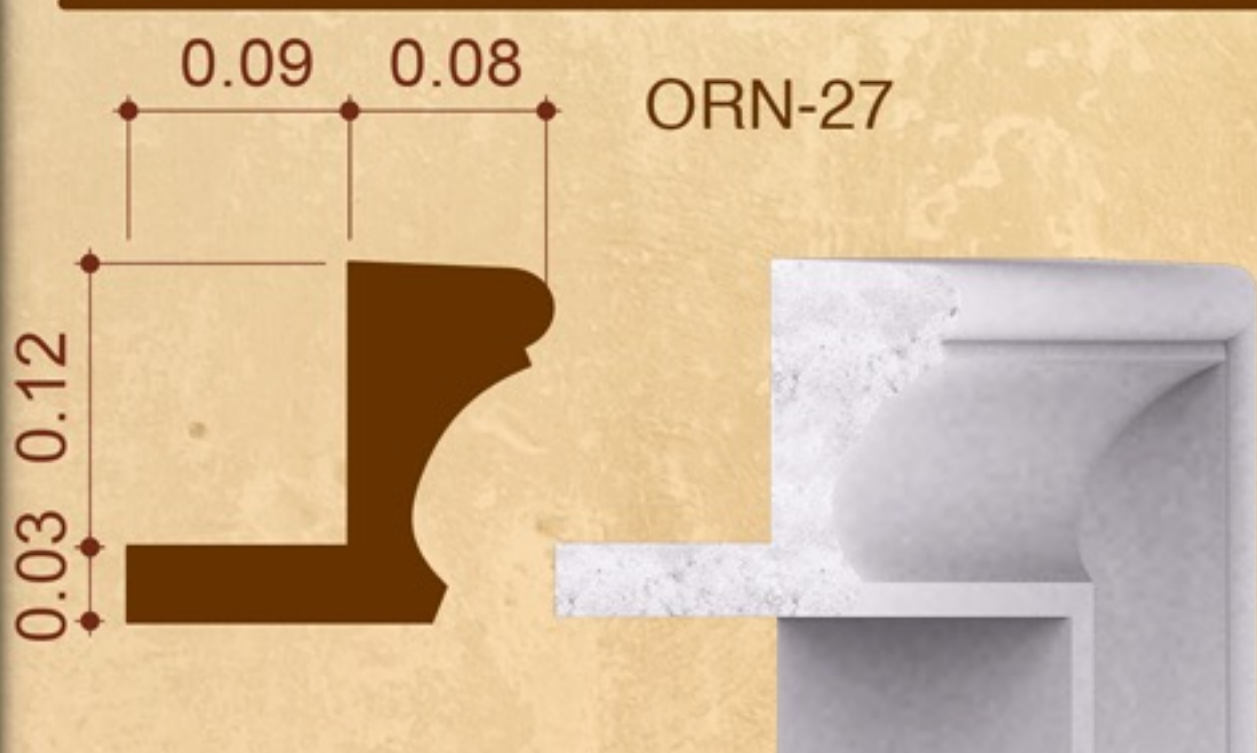
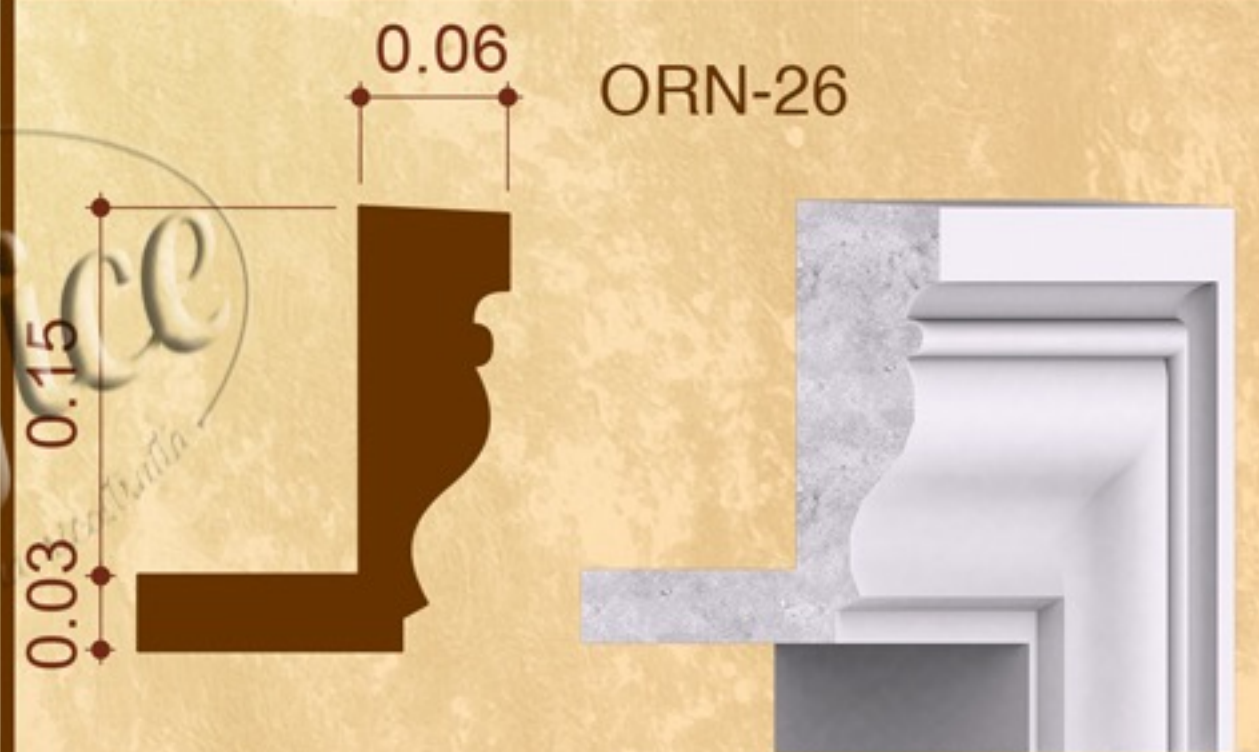
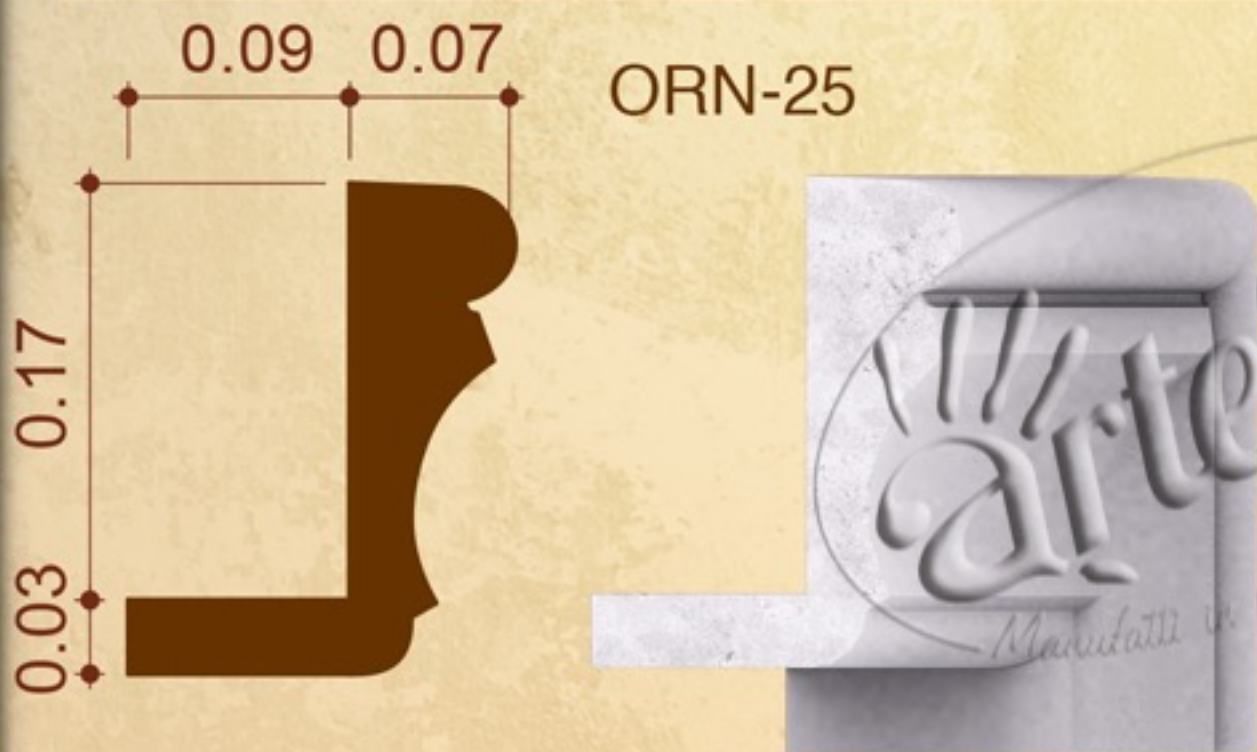
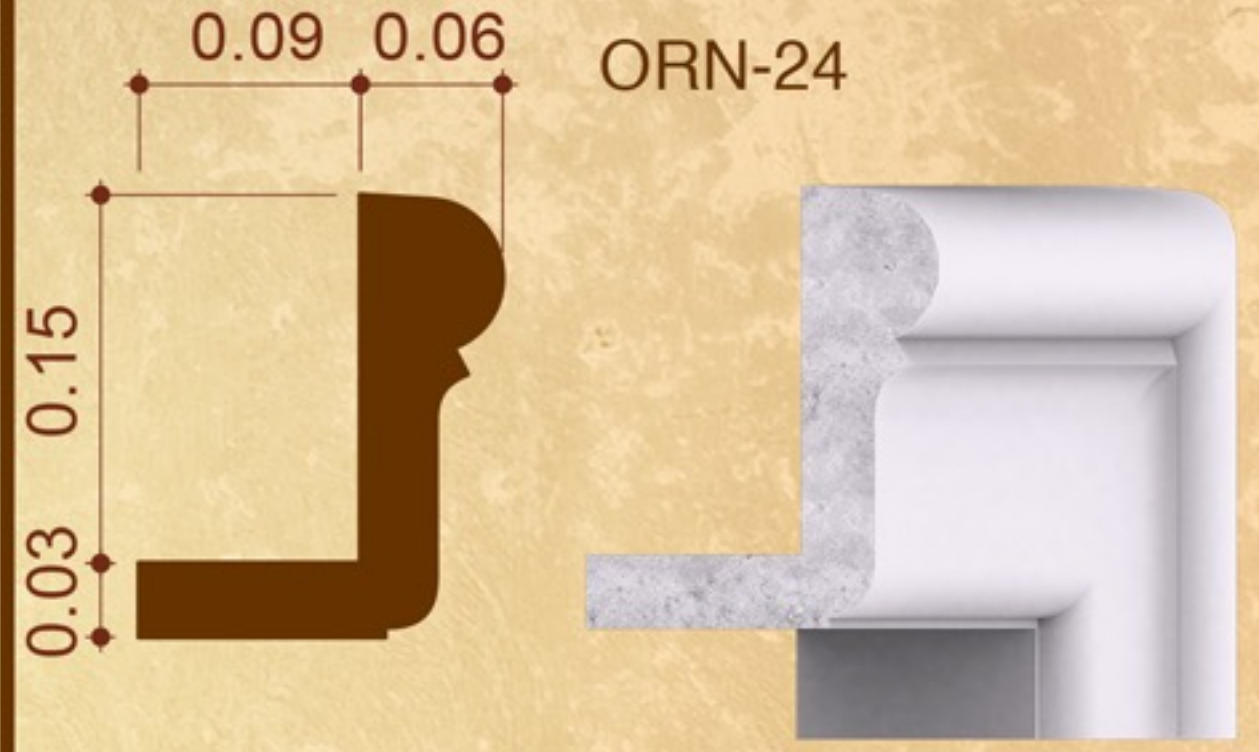
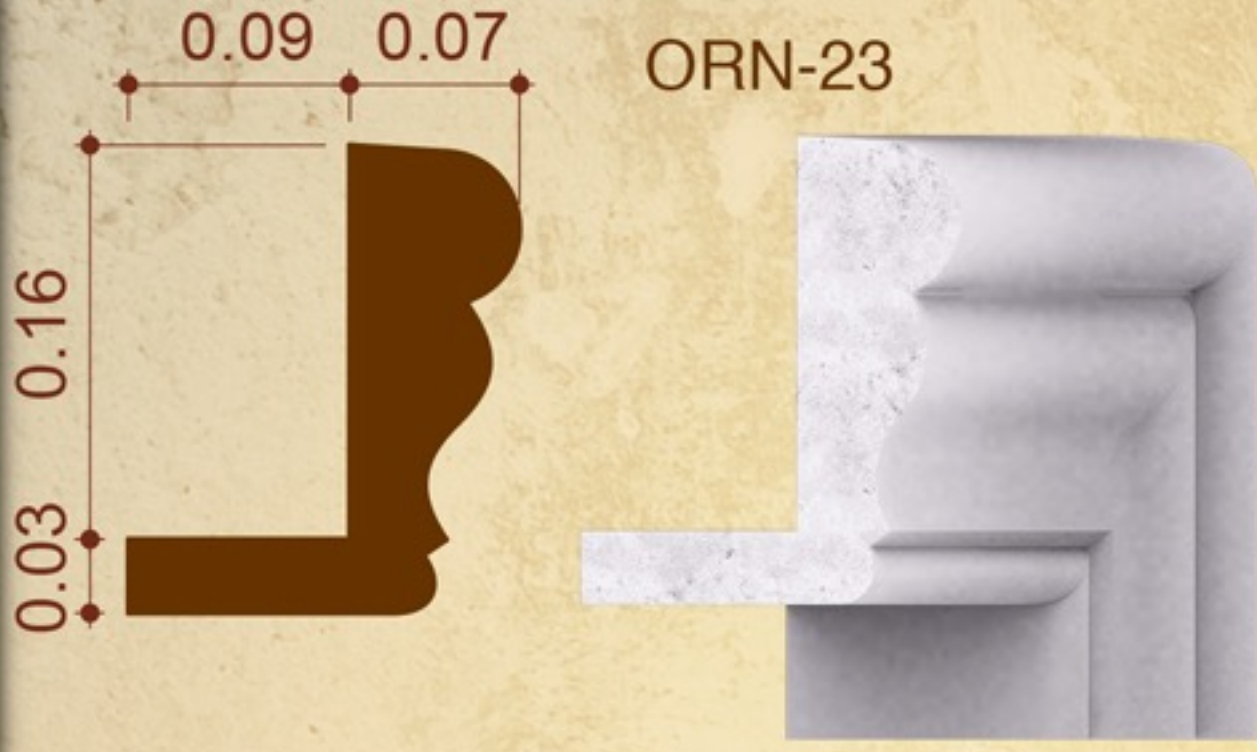
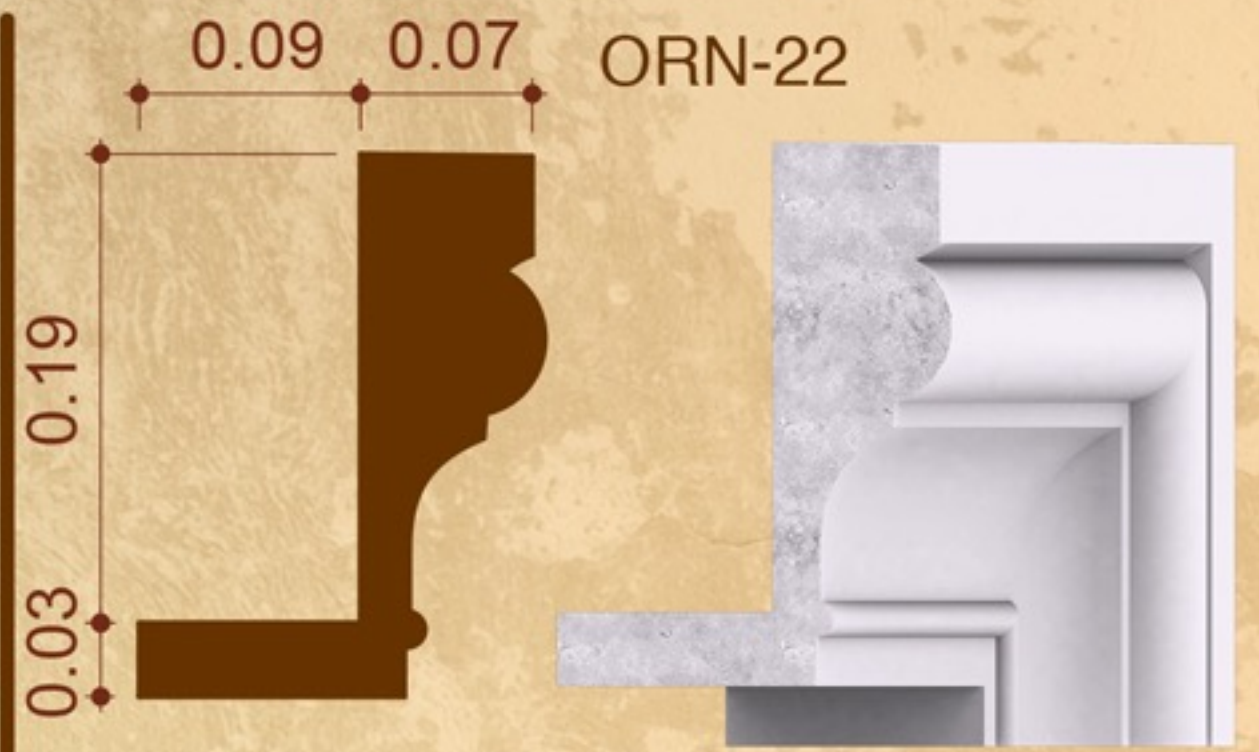
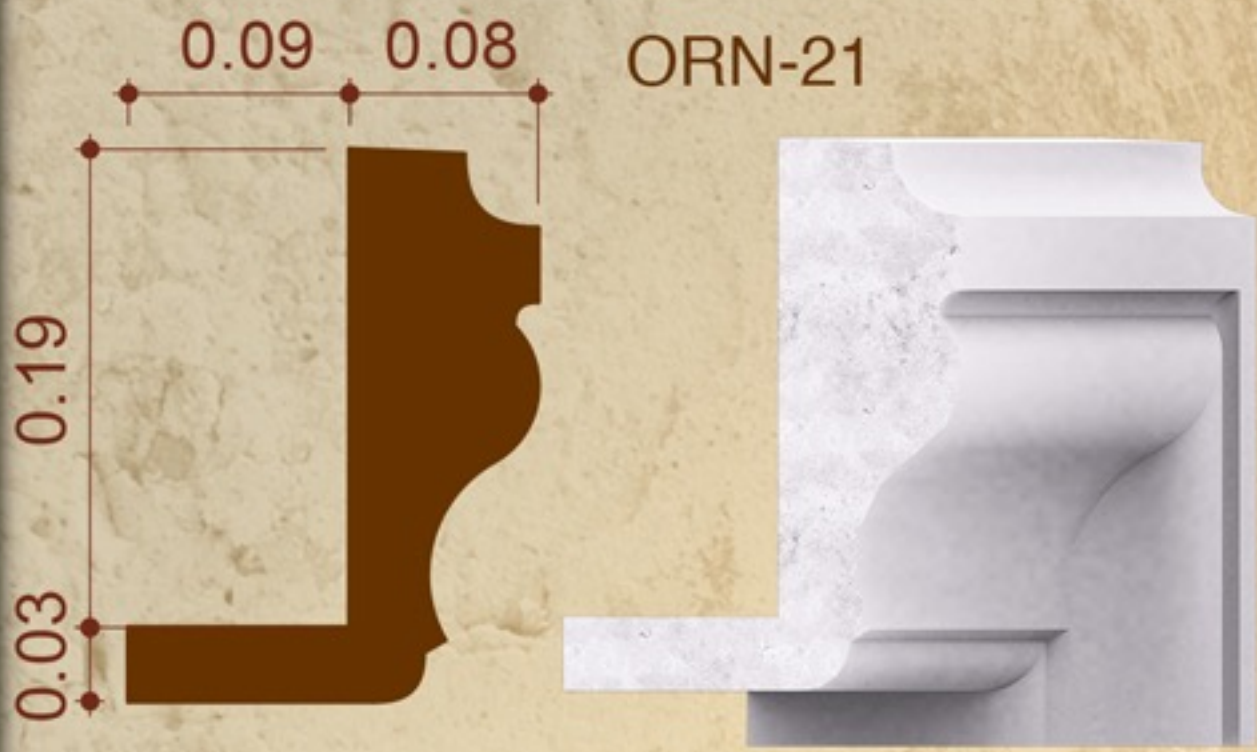



ORN-31



ORN-32



ORN-33



ORN-34

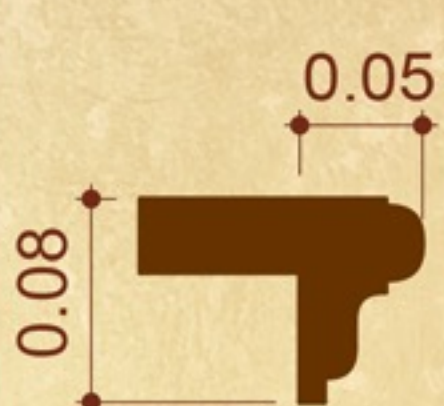

## Ornie

Le ornie in pietra ricostruita sono elementi prefabbricati per la realizzazione di cornici di porte e finestre. La realizzazione su misura delle modanature consente di non avere limitazioni nella forma e nelle dimensioni.

### Montaggio:

Prima dell'applicazione delle cornici vanno preparate le superfici di posa, raschiando lo strato superficiale più friabile dell'intonaco. Nelle boccole presenti all'interno della cornice si avvitano le barre filettate che svolgono la funzione di zanche d'ancoraggio alla parete. Il muro va forato in corrispondenza delle boccole, pulito dalle polveri e riempito di resina epossidica. Sulla superficie della cornice si stende colla cementizia e si fa aderire alla parete. Si conclude con la stuccatura dei giunti.

### Schema cornici

- 1 Ornia (ORN-10)
- 2 Boccola
- 3 Battetta filettata
- 4 Colla cementizia

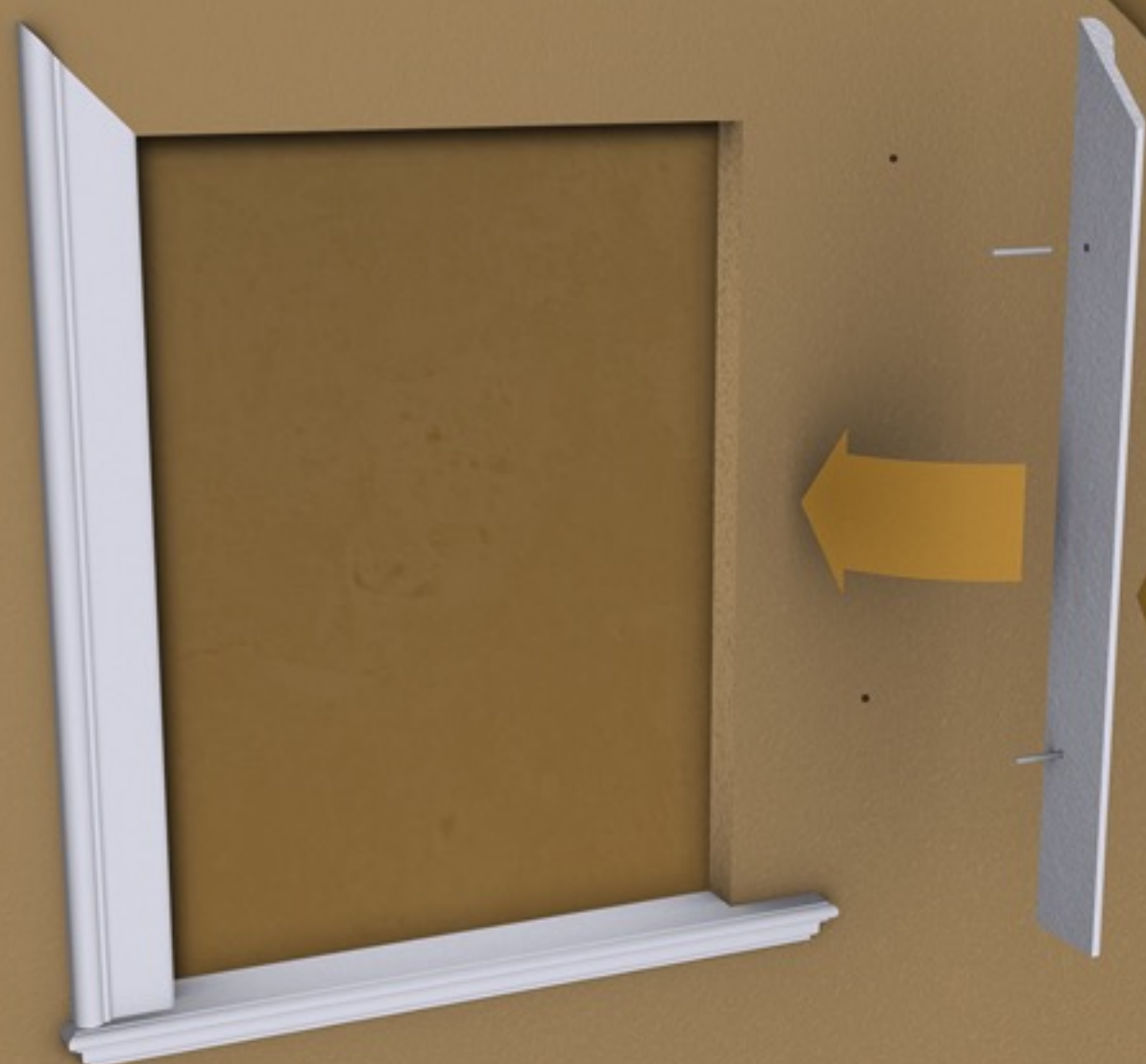

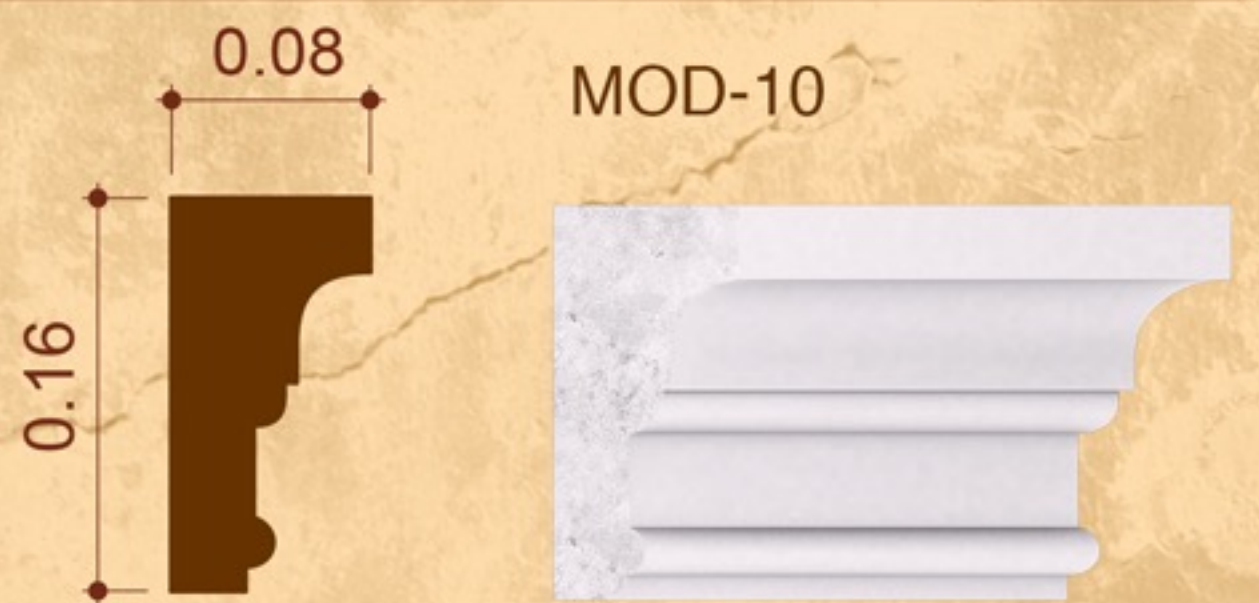
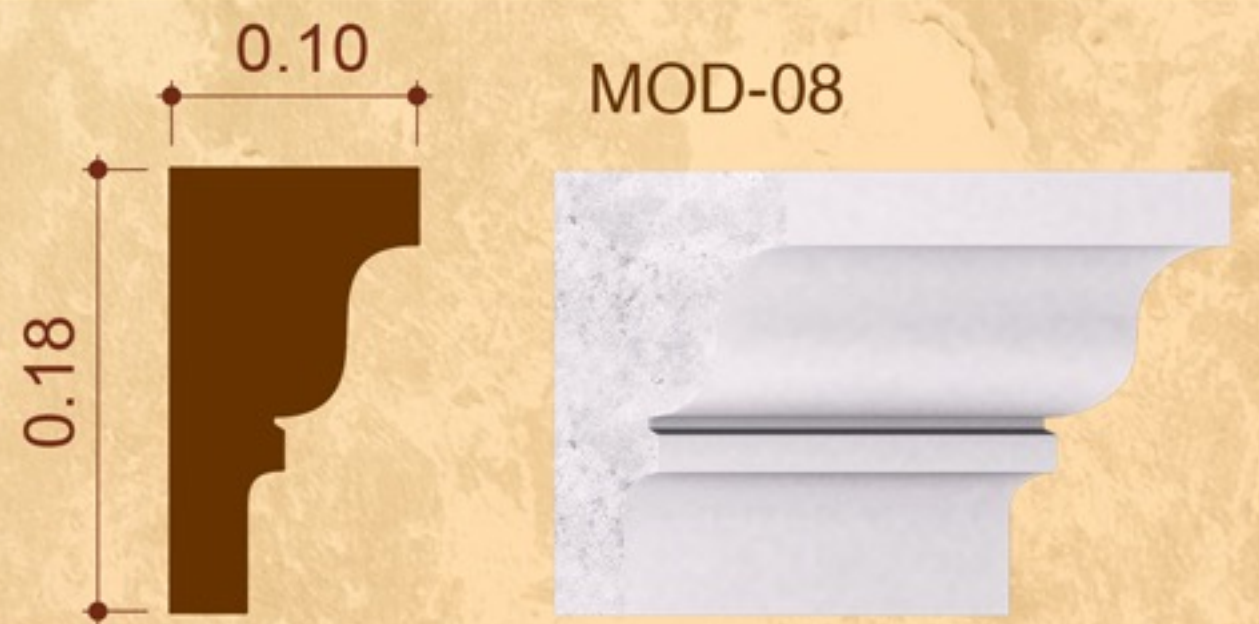
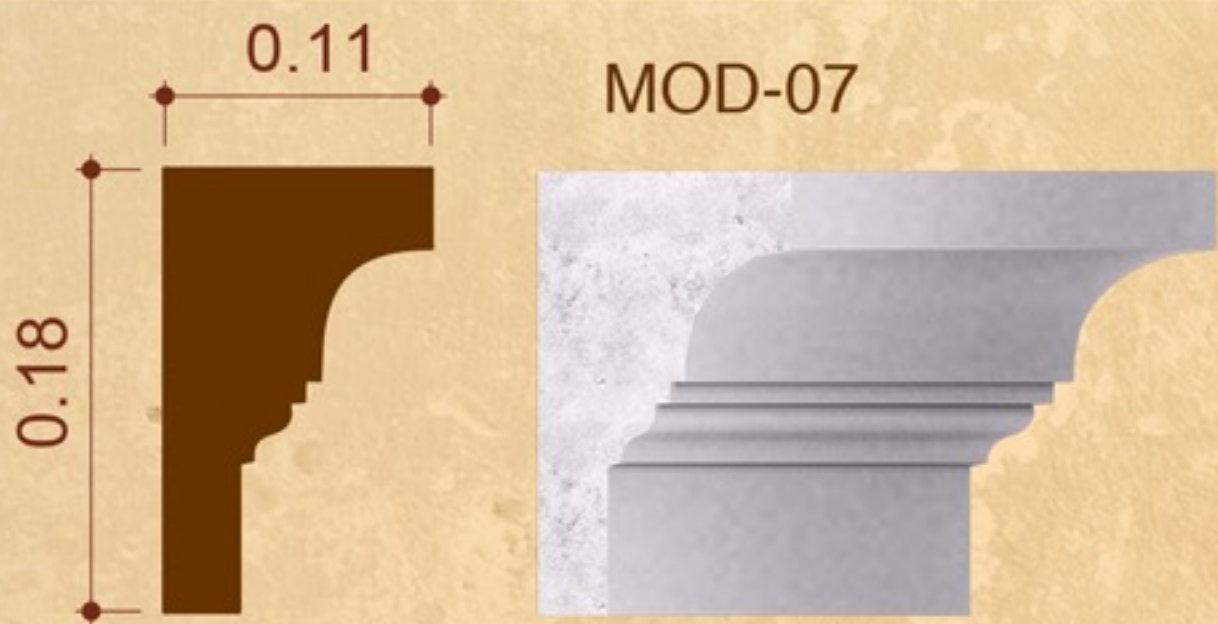
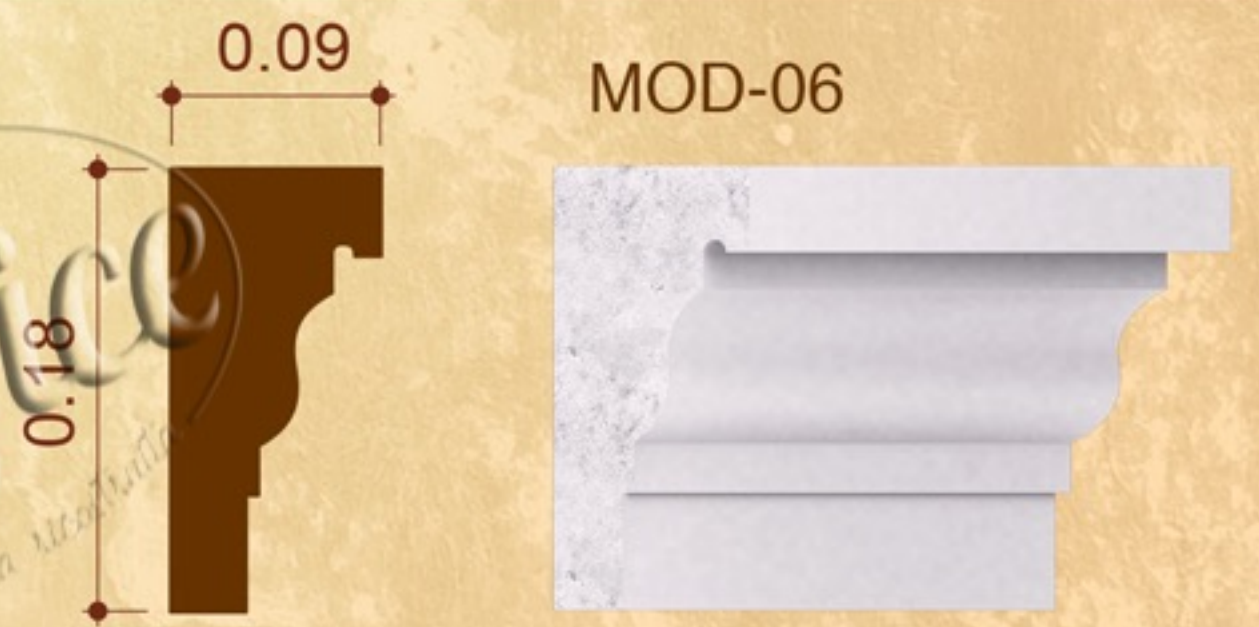
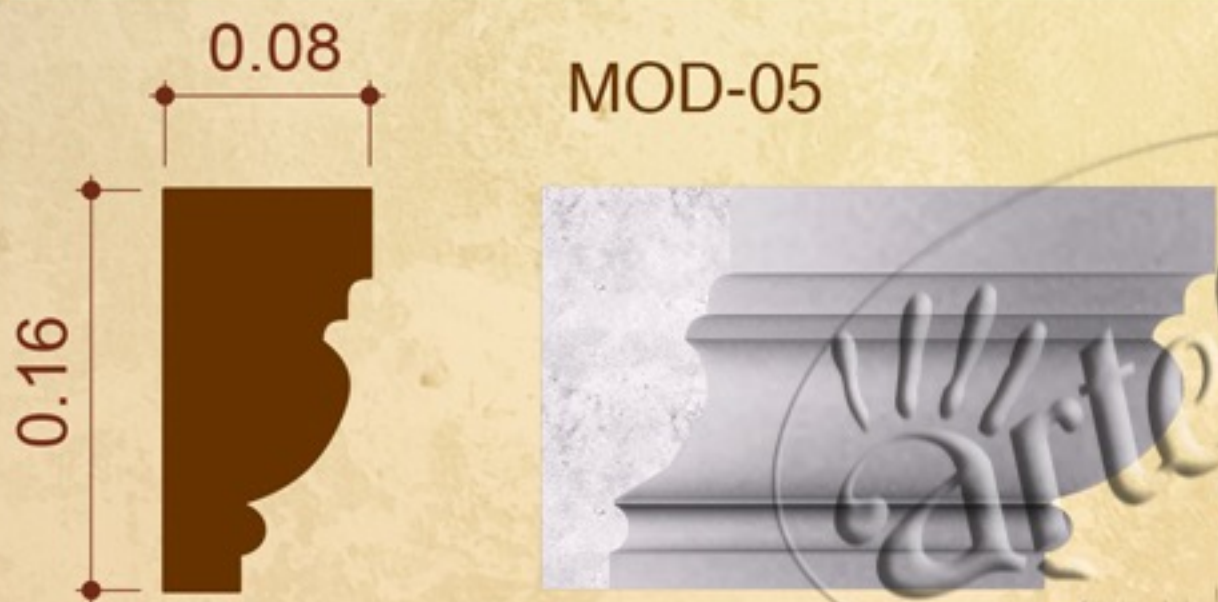
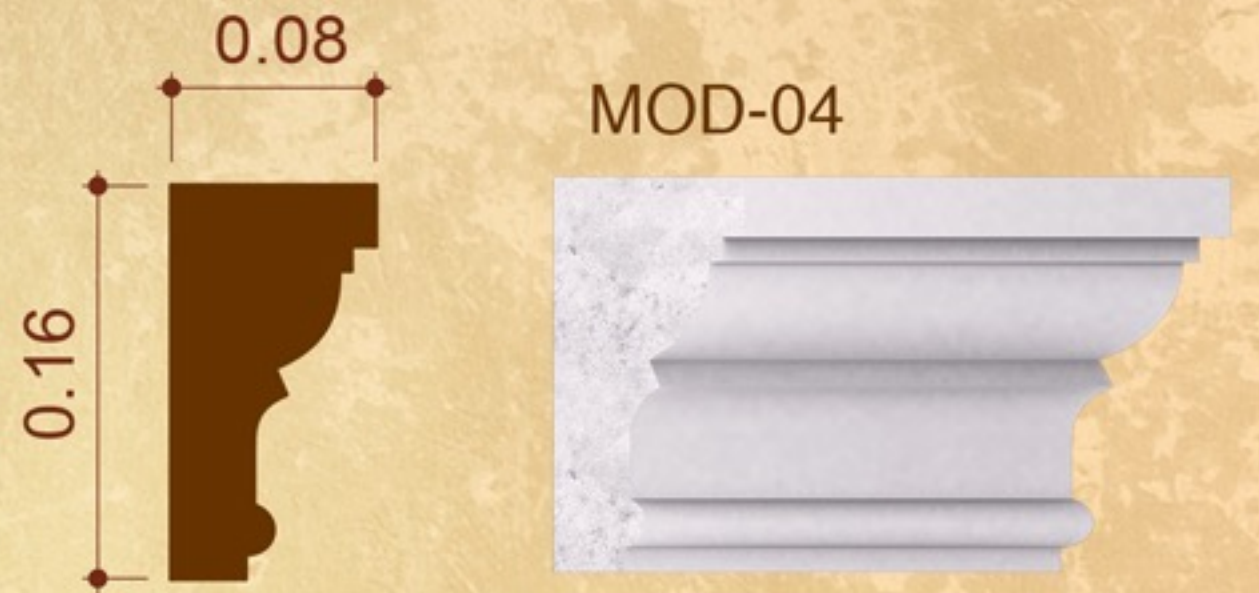
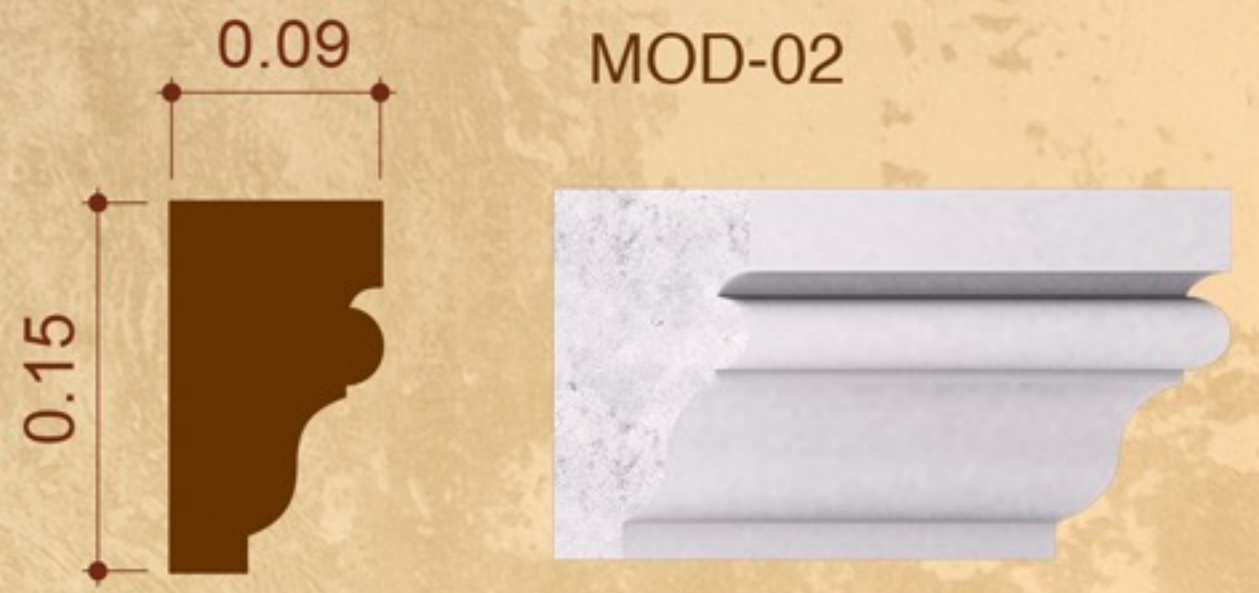
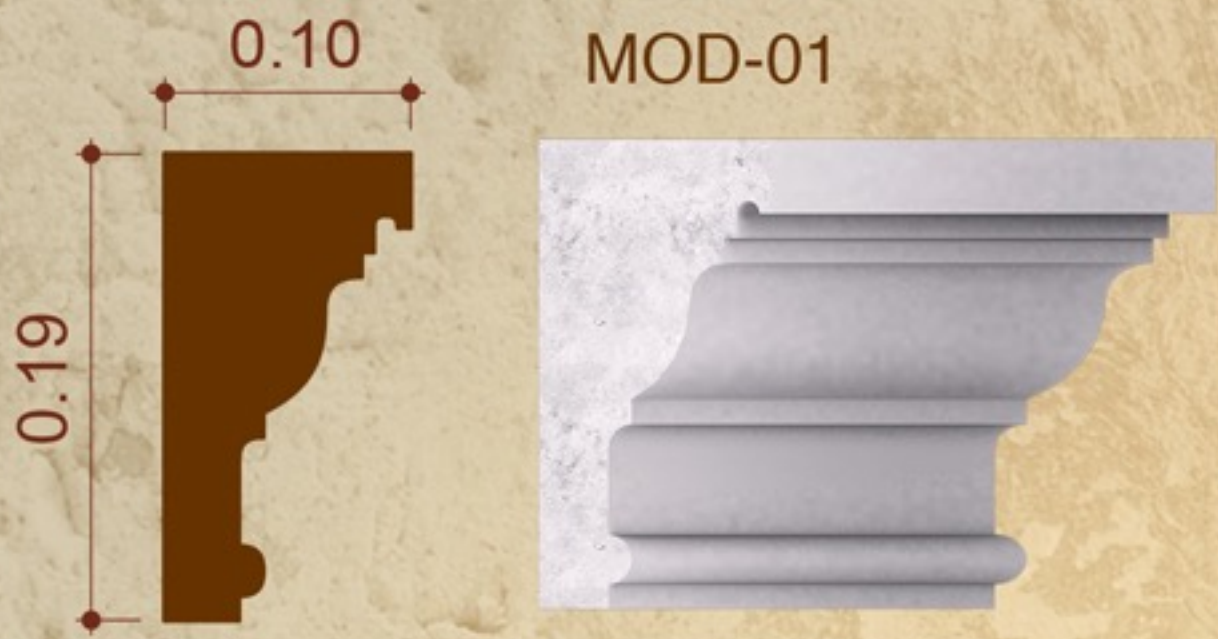



MOD-11



MOD-12



MOD-13

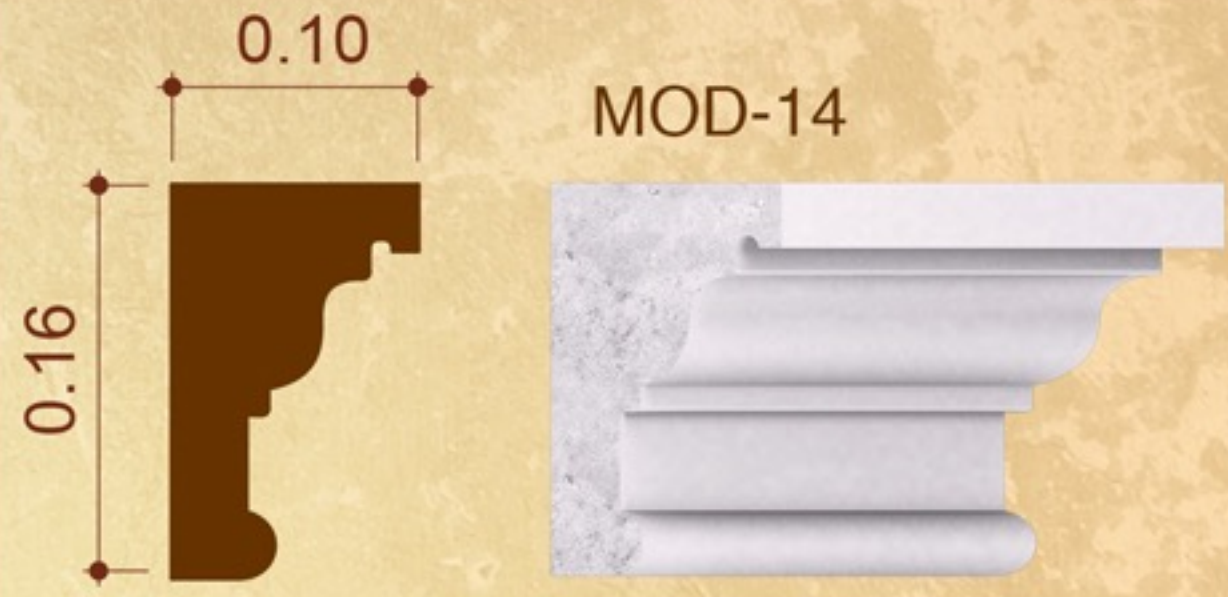

MOD-14



MOD-15



MOD-16

### Terminale per pilastro

- 1 Pilastro in cemento armato
- 2 Copripilastro (MOD-14)
- 3 Copertura terminale

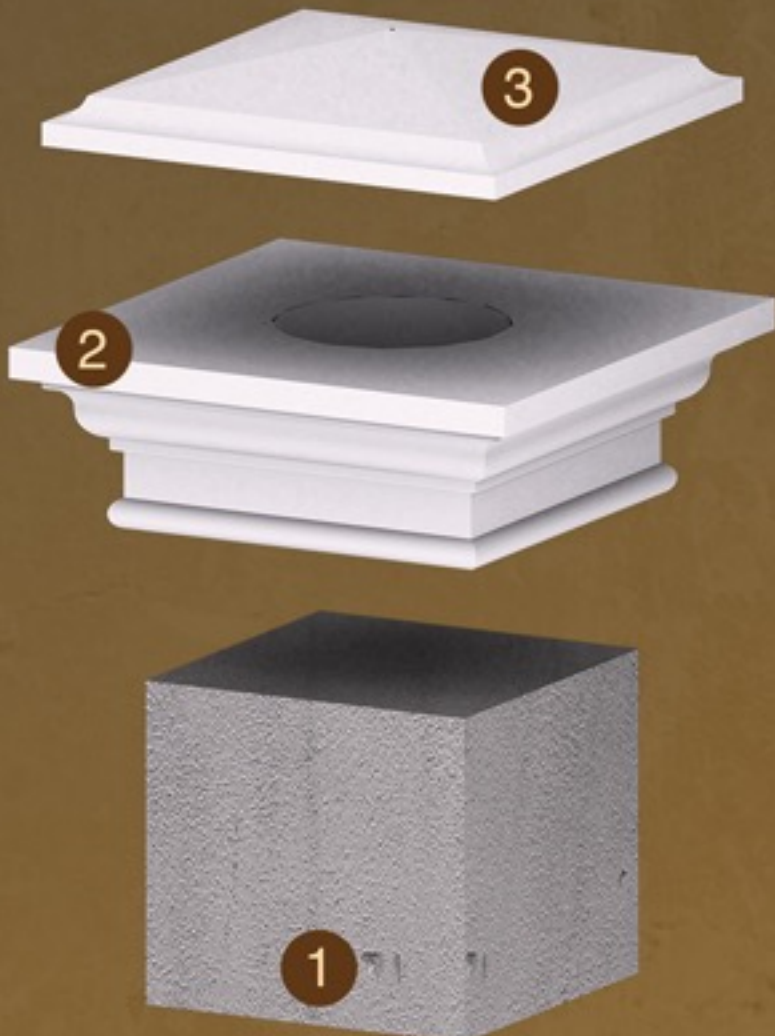

COP-01



COP-02



COP-03



COP-04

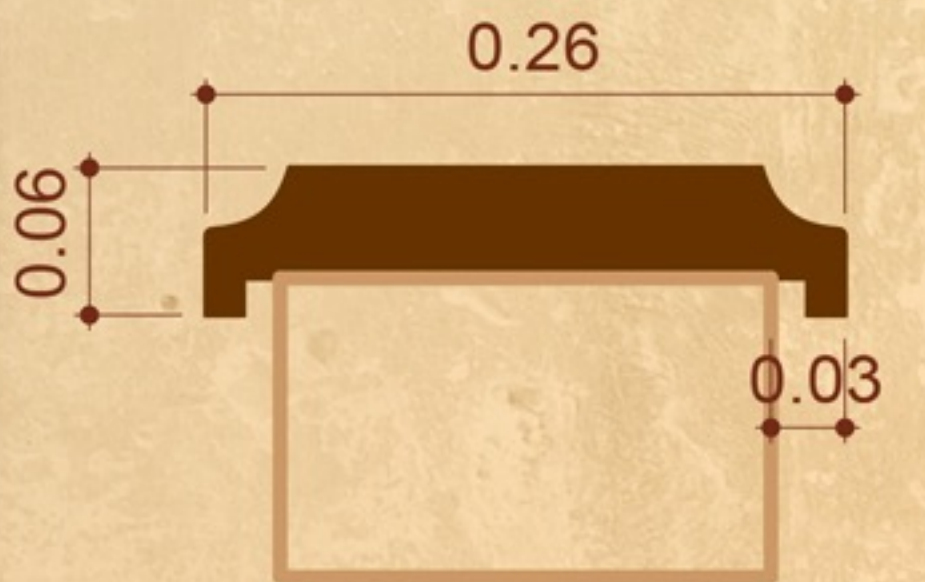

COP-05



## Coprimuro

I coprimuri chiamati anche cimasa, sono prodotti su misura secondo le esigenze e l'estetica che si vuole raggiungere. Svolgono principalmente la funzione di proteggere il manufatto dall'infiltrazione delle acque pluviali per la parte superiore ed evitano che le stesse scivolino e macchino la parete, garantendo al muro una lunga durata. Per rendere completa e perfetta la loro posa, sono disponibili pezzi speciali da impiegare come terminali di chiusura o elementi d'angolo. Le copertine dei muri sono elementi realizzati in diverse dimensioni, varie tipologie di profili e sono dotati su entrambi i lati di frangigoccia per il deflusso dell'acqua piovana. Bisogna prestare attenzione alla larghezza del coprimuro da scegliere, la misura interna del coprimuro deve essere 3 cm in più dello spessore del muro, in modo da avere 1,5 cm di margine per ogni lato.

La forma a U rovesciata evita che l'acqua coli sulla parete e provochi le fastidiosissime colature che deturpano la facciata.

### Montaggio:

La parte superiore del muro va regolarizzata in modo da avere un piano di posa ben livellato.

La posa del coprimuro va effettuata con colla per rivestimenti, iniziando dalla posa del pezzo speciale di partenza e proseguendo fino al pezzo di chiusura. A incollaggio avvenuto, si passa alla sigillatura dei giunti mediante l'impiego di malta per fughe o silicone per esterno.



BAL-01 COLONNINA

cm 15x15, h cm 76

kg 22

BAL-02 PILASTRO

cm 31x31, h cm 89

kg 72

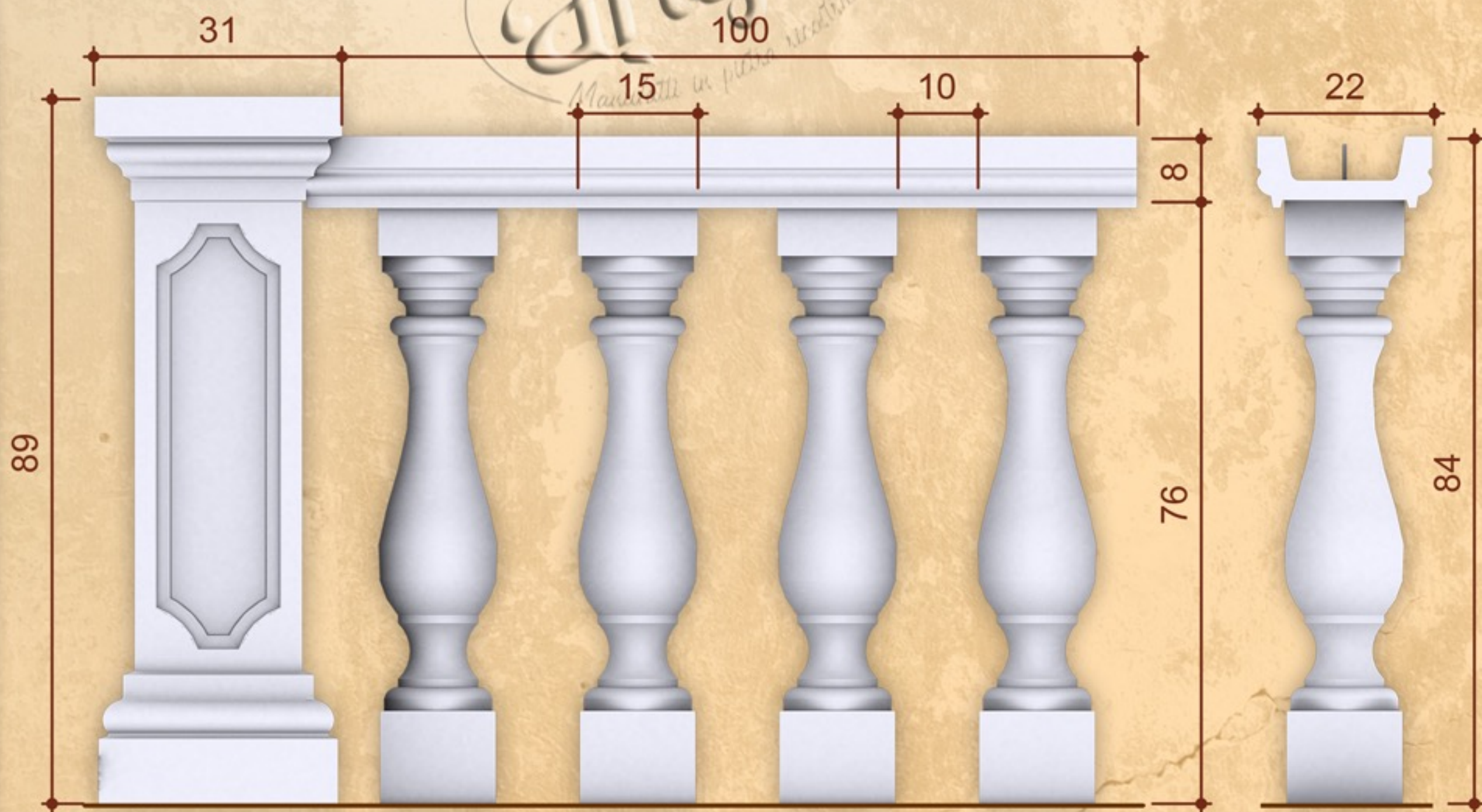

BAL-03 COMPOSIZIONE BALAUSTRRA SEMPLICE

cm 100

kg 140

4 colonnine, 1 base superiore



Artefice

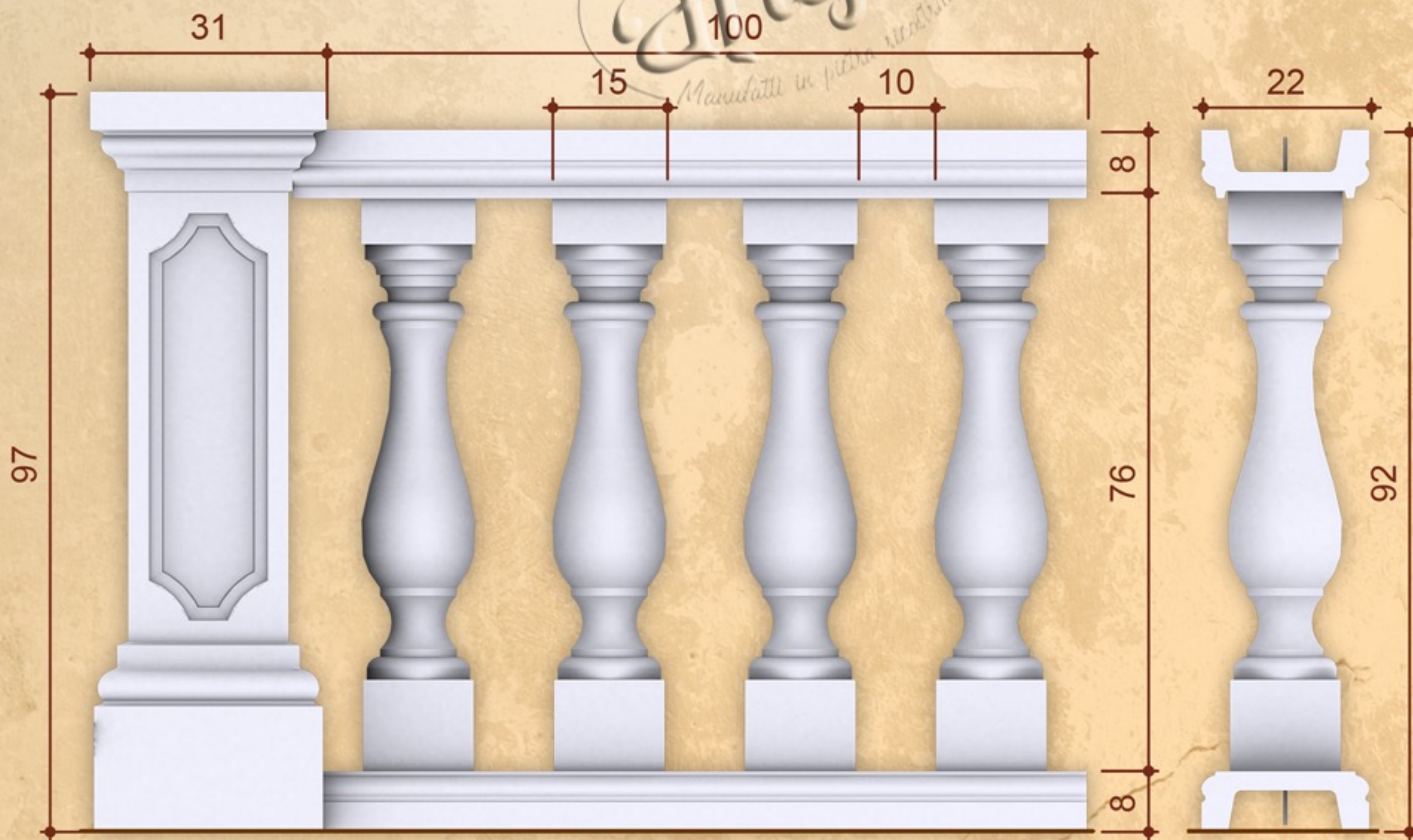

Artefice  
Manufatti in pietra travertina



**BAL-04 COMPOSIZIONE COMPLETA BALAUSTRADA**

 cm 100  kg 150  4 colonnine, 1 base superiore, 1 base inferiore

Collezione Balaustre

BAL-05 COLONNINA TRAVERTINO

cm 14x14, h cm 79

kg 23

BAL-06 PILASTRO TRAVERTINO

cm 31x31, h cm 90

kg 70

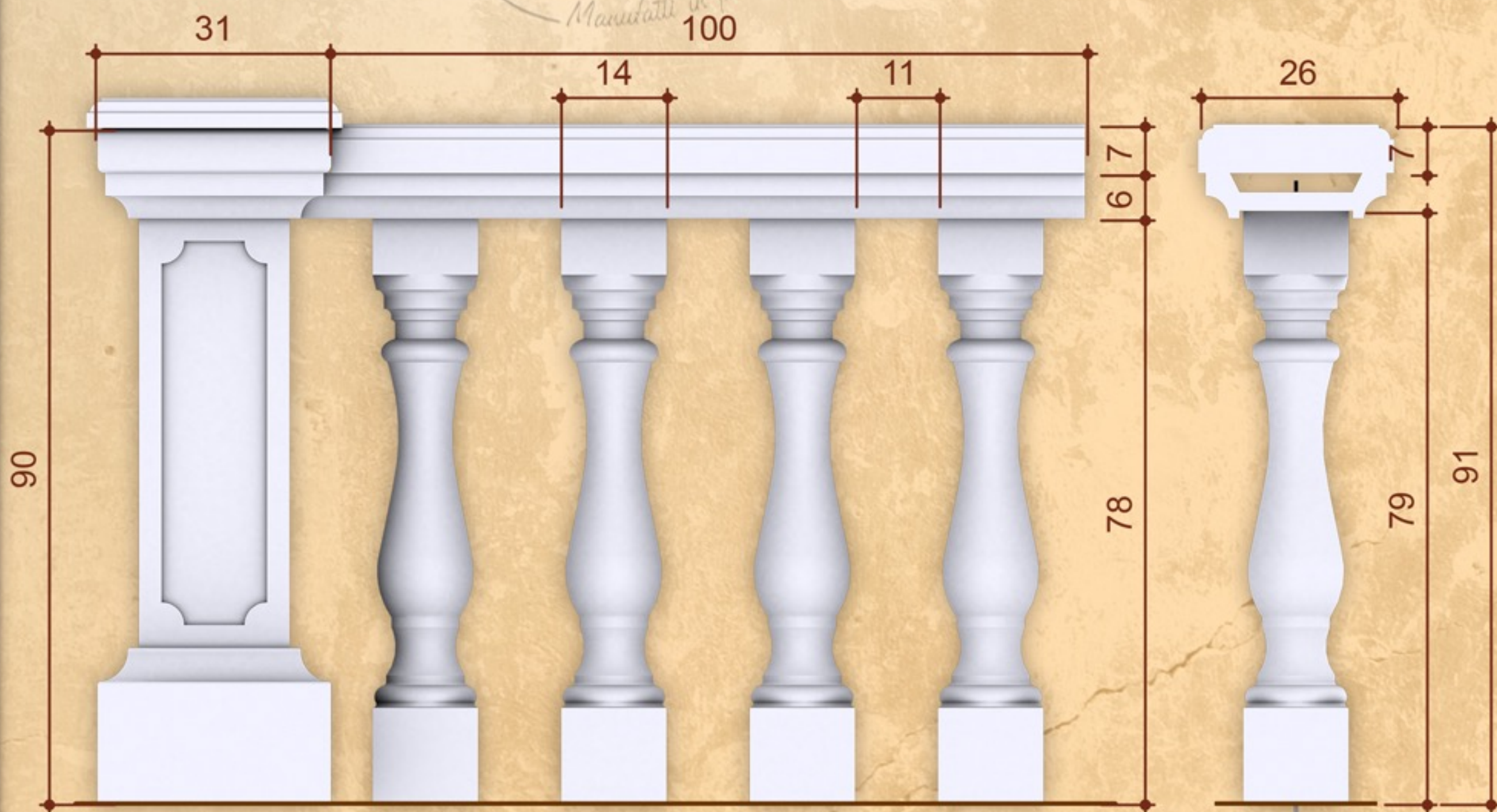

BAL-07 COMPOSIZIONE BALAUSTRATA TRAVERTINO

cm 100

kg 140

4 colonnine, 1 base superiore



## Balaustra

- 1 Base di fondazione
- 2 Base inferiore
- 3 Colonnina
- 4 Base superiore
- 5 Pilastro
- 6 Ferro zincato di collegamento
- 7 Armatura con tondini di ferro
- 8 Getto di completamento

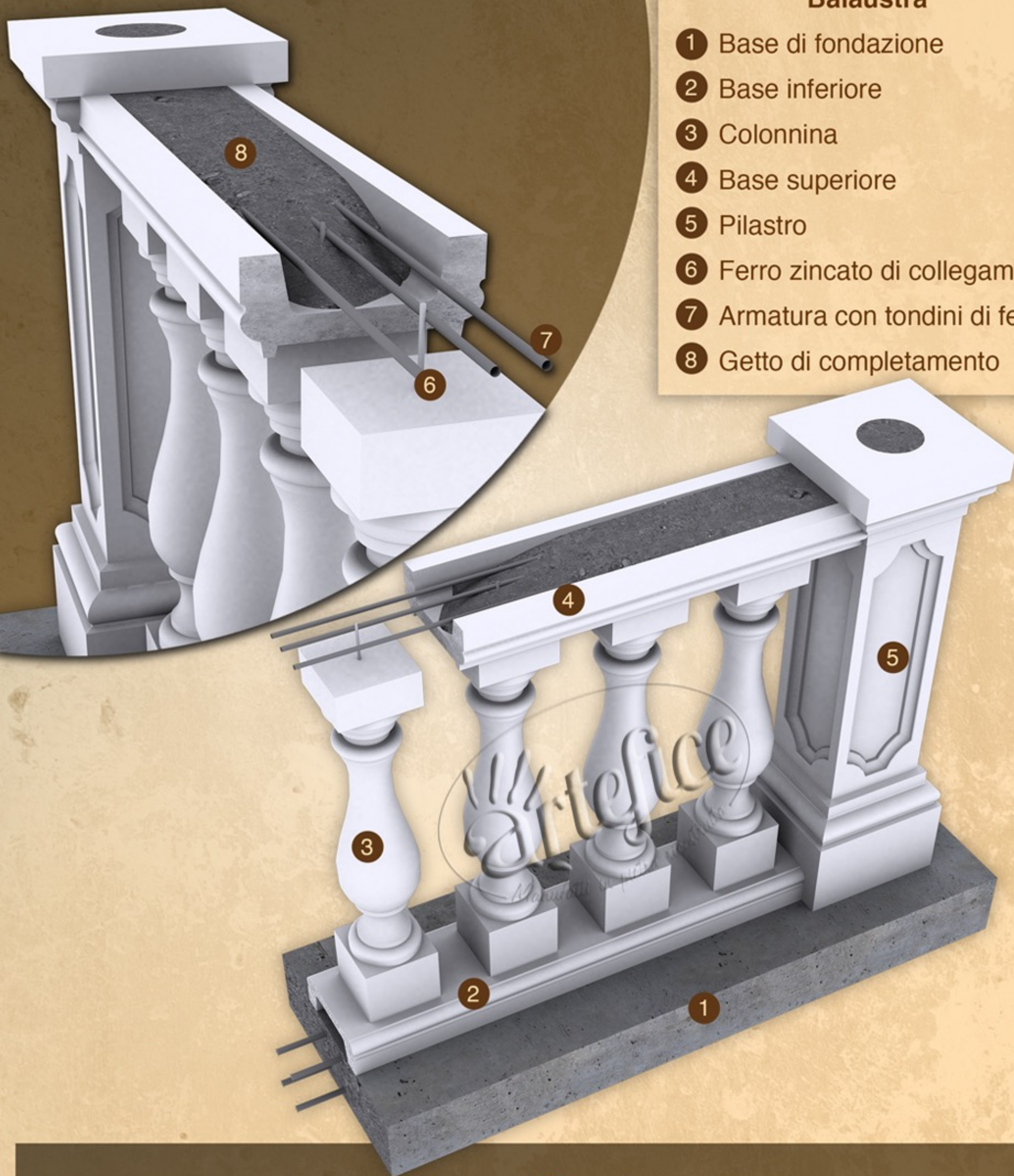

### Schema Balaustra

La balaustra é formata da elementi prefabbricati in pietra ricostruita, composte da colonnine poggiate su base d'appoggio e sormontate da una base superiore di collegamento. Le colonnine sono rinforzate con armatura e ferro zincato. I pilastri sono predisposti per l'ancoraggio della balaustra, da inserire come rompitratta e terminale. Oltre alle composizioni lineari è possibile avere pezzi speciali per scale e curve.

#### Montaggio:

Le balaustre vanno posizionate su fondi robusti e ben livellati. Le basi vanno forate a intervalli stabiliti per consentire il passaggio dei ferri zincati delle colonnine. Il pilastro è predisposto per accogliere l'armatura in tondini di ferro e il calcestruzzo. Nel pilastro vanno eseguiti dei fori per il passaggio dei tondini di collegamento con la vaschetta della base superiore. Il sistema continuo di tondini così disposto forma l'armatura della balaustra. Il riempimento con calcestruzzo del pilastro e della vaschetta superiore garantisce stabilità e sicurezza. Non resta che stuccare opportunamente i giunti con malta cementizia.



REZ-01 RECINZIONE LISCIA

 cm 23, h cm 190

 kg 400

 4 componente

 Disponibile su misura

Artefice





Artefice  
Maurizio

Collezione Recinzioni

**REZ-02 RECINZIONE MATTONI**

 cm 25, h cm 55 - 185

 kg 500

 8 componenti

 Disponibile su misura

*Collezione Pilastrini e Colonne*



**PIL-02 BLOCCO PIETRA**



cm 38x38, h cm 25



kg 39



1 componenti



**PIL-01 MEZZO BLOCCO PIETRA**

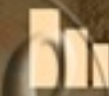

cm 38x19, h cm 25



kg 19



1 componenti



**PIL-03 MEZZO BLOCCO TRAVERINO**

 cm 38x19, h cm 25

 kg 15

 1 componenti



*Collezione Pilastrini e Colonne*

**PIL-04 BLOCCO 38 TRAVERTINO**

 cm 38x38, h cm 25

 kg 36

 1 componenti



### PIL-05 PILASTRO BUGNE

 cm 34x34, h cm 216

 kg 322

 2 componenti

 Disponibile su misura

### PIL-06 MEZZA BUGNA

 cm 40x20, h cm 22

 kg 16

 1 componente

 Disponibile su misura

*Artefice*  
Manifatti in pietra naturale



### PIL-07 ELEMENTO TORTILE 45

 cm 45x45, h cm 9

 kg 27

 1 componenti

### PIL-08 ELEMENTO TORTILE 35

 cm 35x35, h cm 9

 kg 15

 1 componenti

### PIL-09 ELEMENTO TORTILE 25

 cm 25x25, h cm 9

 kg 7

 1 componenti

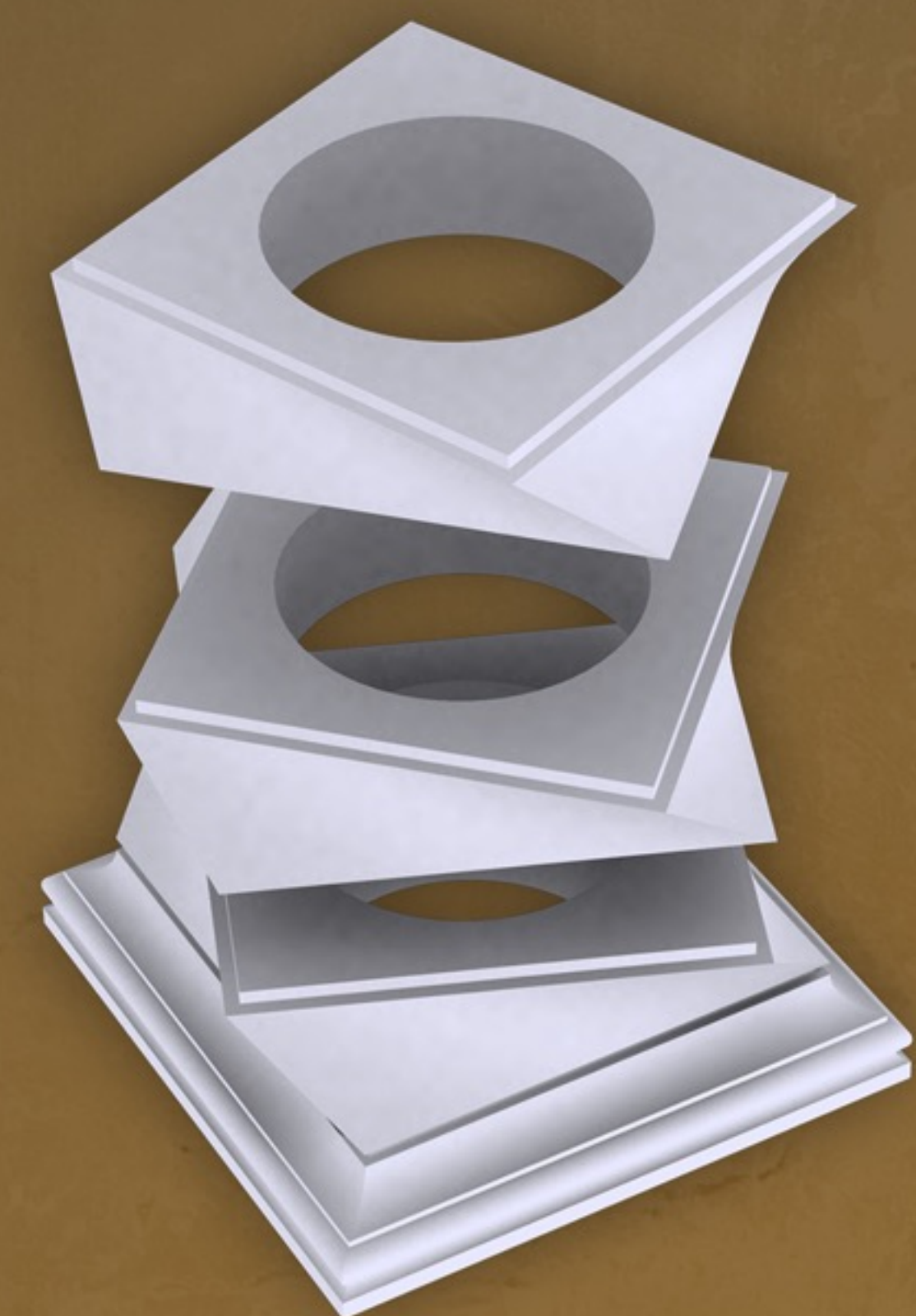

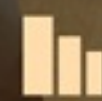

*Collezione Pilastrini e Colonne*

PIL-10 PILASTRO MATTONI 40

 cm 41x41, h cm 240

 kg 520

 1 componente

 Disponibile su misura



PIL-11 PILASTRO MATTONI 30

 cm 30x30, h cm 220

 kg 285

 1 componente

 Disponibile su misura



## PIL-12 PILASTRO A FASCE 34

 cm 34x34, h cm 220

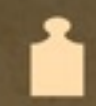
 kg 364

 1 componente

 Disponibile su misura



## PIL-13 PILASTRO A FASCE 29

 cm 29x29, h cm 200

 kg 247

 1 componente

 Disponibile su misura

*Collezione Pilastrini e Colonne*

PIL-14 PILASTRO CON MATTONI

 cm 44x44, h cm 230

 kg 574

 1 componente

 Disponibile su misura, mattoni esclusi

PIL-15 PILASTRO LISCIO

 cm 43x43, h cm 220

 kg 444

 1 componente

 Disponibile su misura



### PIL-16 PILASTRO FASCE 5

 cm 44x44, h cm 225

 kg 478

 1 componente

 Disponibile su misura

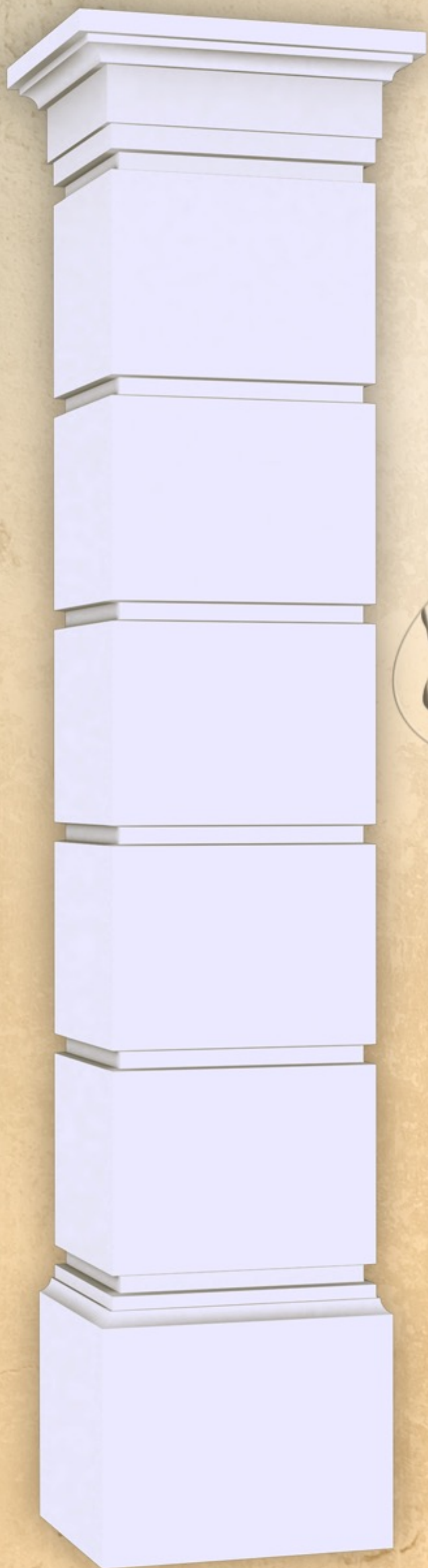

*Artefice*  
Manufatti in pietra naturale

### PIL-17 PILASTRO FASCE 8

 cm 44x44, h cm 236

 kg 515

 1 componente

 Disponibile su misura

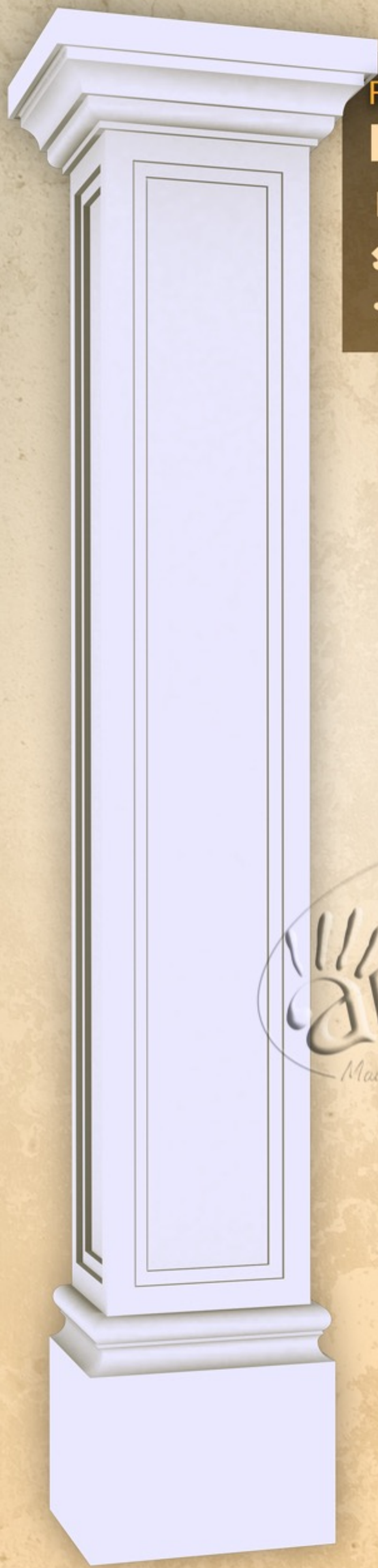

**PIL-18 PILASTRO CON SPECCHIATURE**

 cm 36x36, h cm 220

 kg 280

 1 componente

 Disponibile su misura

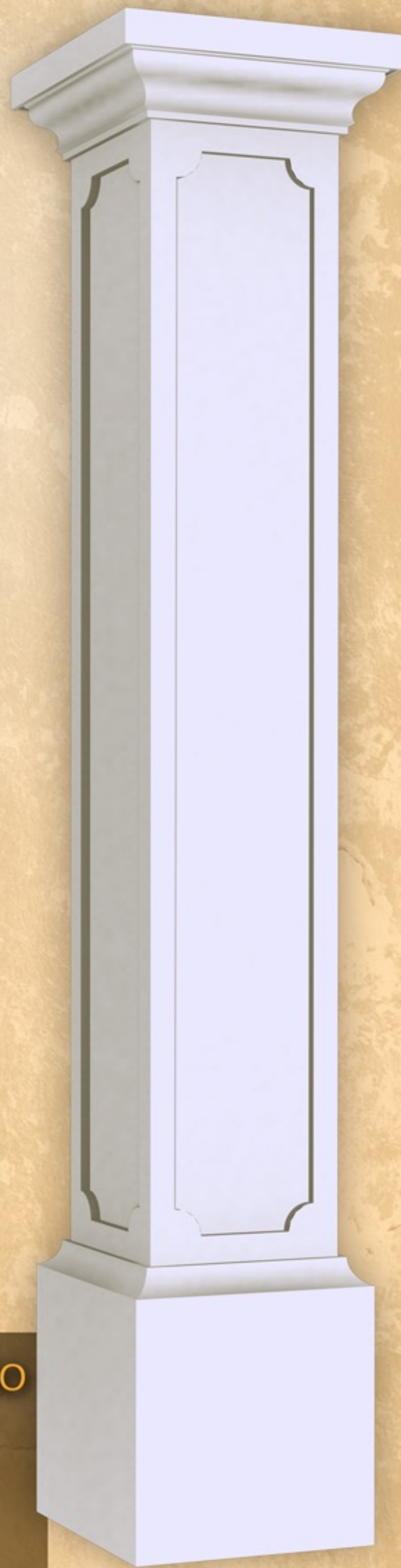

**PIL-19 PILASTRO CON RIQUADRO**

 cm 38x38, h cm 220

 kg 310

 1 componente

 Disponibile su misura





**PIL-20 COLONNA TUSCANICA**  
cm 35x35, h cm 220  
kg 200  
3 componenti  
Disponibile su misura

*Collezione Pilastrini e Colonne*

**PIL-21 COLONNA TRAVERTINO 30**

 cm 40x40, h cm 232

 kg 205

 3 componenti



**PIL-22 BLOCCO 25 TRAVERTINO**

 cm 25x25, h cm 20

 kg 16

 1 componenti



## Scheda Pilastrini e Colonne

Le colonne ed i pilastrini sono strutture prefabbricate in pietra ricostruita, disponibili su misura e in diversi modelli. I nostri manufatti sono casseforme a perdere, che richiedono l'integrazione con armature in acciaio ed un getto di completamento in calcestruzzo per creare una struttura portante. Con questo sistema è garantita la massima flessibilità formale e dimensionale, con costi contenuti e ridotti tempi d'esecuzione in cantiere.

### Montaggio:

Una volta scelto il modello e le dimensioni, in cantiere si predispone il plinto di fondazione con i ferri di collegamento. L'armatura in acciaio deve essere disposta con sezione circolare e dimensionata secondo il foro del pilastrino scelto. Si cala l'elemento prefabbricato sull'armatura, e si prepara il getto in calcestruzzo di riempimento. Si completa collocando con malta cementizia il capitello di chiusura.

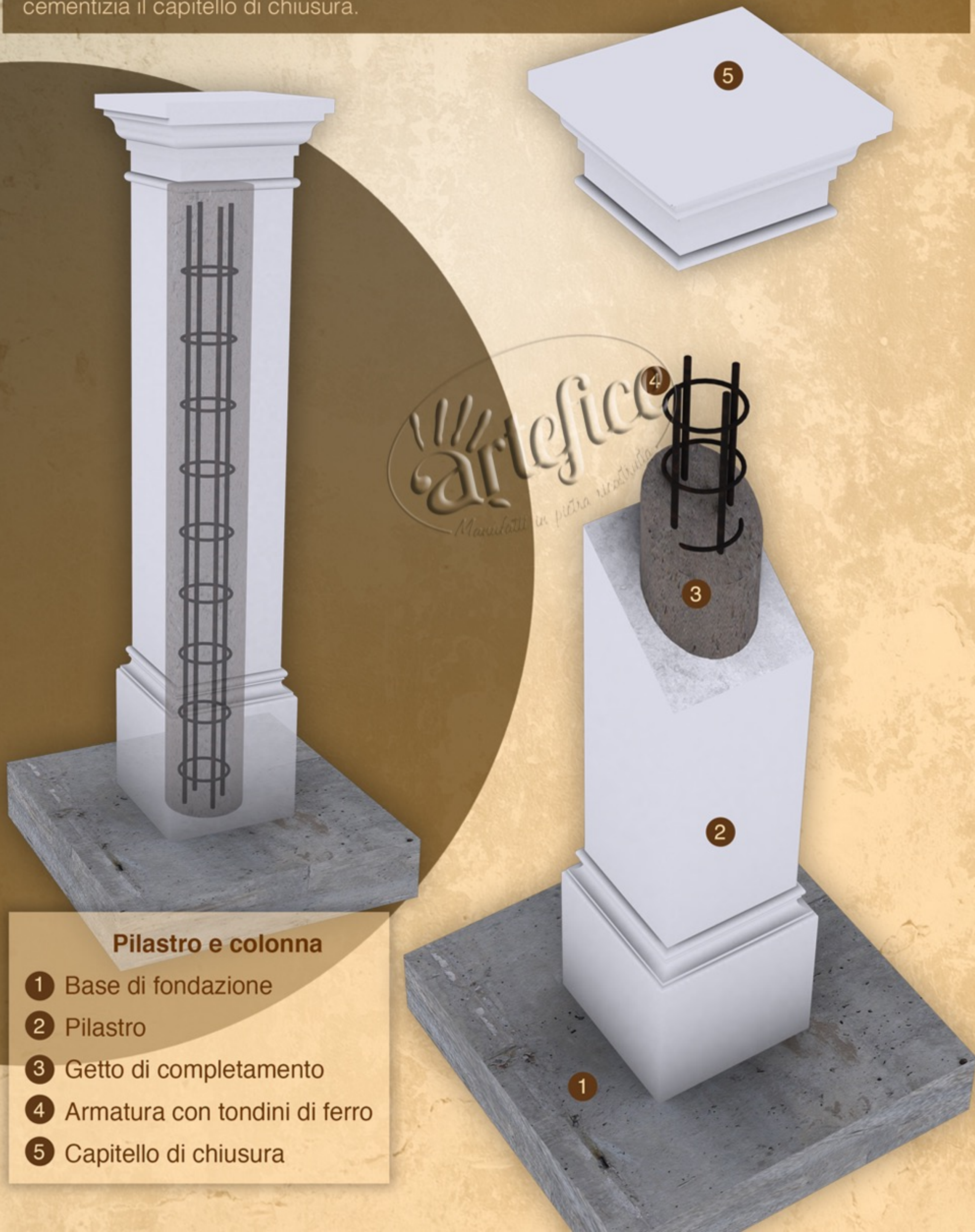

### Pilastrino e colonna

- 1 Base di fondazione
- 2 Pilastrino
- 3 Getto di completamento
- 4 Armatura con tondini di ferro
- 5 Capitello di chiusura



**ANG-01 ANGOLO BUCCIATO**

 cm 45x30, h cm 25

 kg 13



Artefice



ANG-02 ANGOLO 25

 cm 25x25, h cm 25

 kg 8



ANG-03 ANGOLO 40

 cm 40x40, h cm 25

 kg 13

Collezione Rivestimenti

Collezione Aiuole e Passi



AIP-01 PASSO 40

 cm 40x40

 kg 15

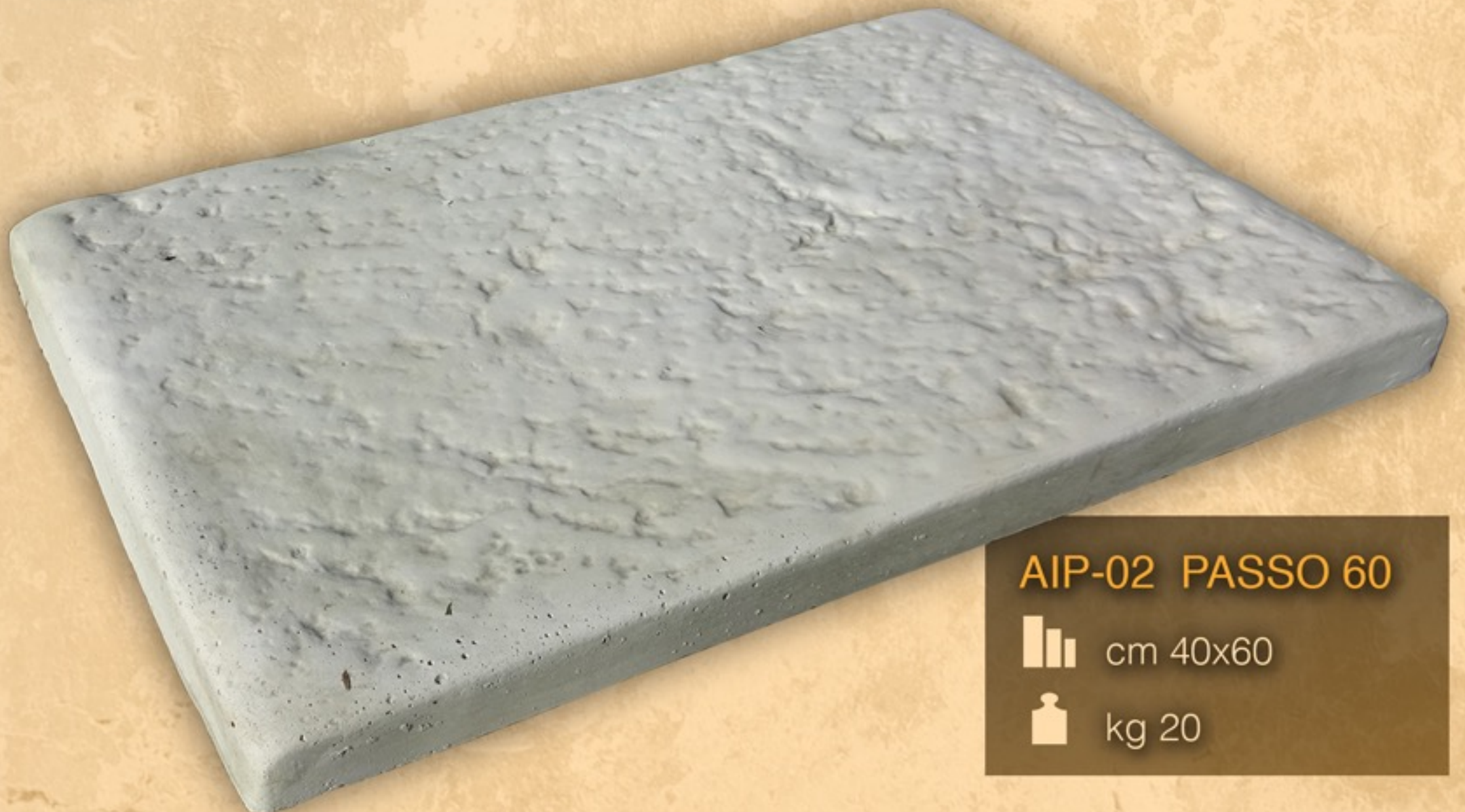

AIP-02 PASSO 60

 cm 40x60

 kg 20

Artefice



AIP-03 AIUOLA A BLOCCHI



cm 110x7, h cm 37



kg 45





Collezione Aiuole e Passi

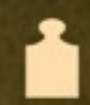

**PAT-01 PANCHINA VOLUTE**

 cm 175 x 50, h cm 85

 kg 205

 4 componenti



**PAT-02 PANCA VOLUTE**

 cm 182 x 40, h cm 70

 kg 205

 3 componenti



**PAT-03 PANCHINA PALLADIANA**

 cm 180x60, h cm 85

 kg 205

 4 componenti



**PAT-04 PANCA PALLADIANA**

 cm 180x41, h cm 45

 kg 205

 3 componenti



**PAT-05 PANCA LIBRO**

 cm 180x41, h cm 45

 kg 205

 3 componenti



**PAT-06 PANCA MONOBLOCCO**

 cm 200 x 45, h cm 45

 kg 170



**PAT-07 PANCHINA ESTE**

 cm 180 x 70, h cm 85

 kg 280

 4 componenti

Artesifice

PAT-08 TAVOLO VIESTE

cm 180 x 90, h cm 81

kg 350

3 componenti



Artesifice  
Mantellate in pietra



Intarsio per tavolo su misura

Collezione Panche e Tavoli



**PAT-09 TAVOLO CEMENTINA**

 ø cm 90

 kg 60

 1 componente

 Base in ferro non inclusa





**CAL-01 CONSOLLE TULIPANO**

 cm 28x13, h cm 90

 kg 55



**CAL-02 COLONNINA SIRONE**

 cm 27x27, h cm 45

 kg 35





**CAL-03 LIBERTY ALTA**

 cm 23x23, h cm 84

 kg 42

**CAL-04 LIBERTY BASSA**

 cm 23x23, h cm 54

 kg 30

*Collezione Capitelli e Consolle*



CAL-05 CAPITELLO FLOREALE

cm 55x10, h cm 30

kg 15

CAL-06 MILANO

cm 16x32, h cm 39

kg 14



CAL-07 TORINO

cm 13x14, h cm 29

kg 5



CAL-08 VENEZIA

cm 10x8, h cm 16

kg 3



CAL-09 FIRENZE

cm 20x10, h cm 26

kg 5





CAL-10 PARMA

cm 18x12, h cm 27

kg 6

**BSR-01 ROSETTA GRANDE**

 cm 27x27

 kg 3

**BSR-02 ROSETTA PICCOLA**

 cm 16x16

 kg 1

**BSR-03 FIORONE**

 cm 17x17

 kg 1

**INGRESSO**

**BSR-04 INSEGNA SU MISURA**

 Disponibile con dimensioni e testo su misura

*Collezione Bassorilievi*



**BSR-05 MERIDIANA**

 cm 93, h cm 63

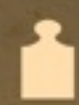
 kg 68



**BSR-06 MEZZA LUNA**

 cm 115, h cm 51

 kg 34

*Artificio*  
Manifatti in pietra naturale



**BSR-07 BIGA ROMANA**

 cm 95, h cm 98

 kg 50





**BSR-08 TRE AMORINI**

 cm 70, h cm 60

 kg 20

**BSR-09 SOLE**

 cm 56, h cm 56

 kg 13



**BSR-10 TRALCIO D'UVA**

 cm 68, h cm 68

 kg 16



**BSR-11 LIRA**

 cm 53, h cm 53

 kg 13



*Collezione Bassorilievi*



TRM-01 OBELISCO GRANDE

cm 30x30, h cm 50

kg 40



TRM-02 OBELISCO PICCOLO

cm 20x20, h cm 35

kg 20



TRM-03 SFERA 30

cm 26x26, h cm 48

kg 47



TRM-05 SFERA 20

cm 24x24, h cm 41

kg 29



TRM-04 SFERA TONDA 30

cm 30x30, h cm 50

kg 42



**LNT-01 LANTERNA  
TRAVERTINO PICCOLA**

 cm 27x27, h cm 45

 kg 18

 2 componenti

**LNT-02 LANTERNA  
TRAVERTINO GRANDE**

 cm 35x35, h cm 58

 kg 40

 2 componenti

artefice

Collezione Lanterne

**LNT-03 LANTERNA  
AURA PICCOLA**

 cm 23x23, h cm 42

 kg 16

 2 componenti

**LNT-04 LANTERNA  
AURA MEDIA**

 cm 30x30, h cm 56

 kg 34

 2 componenti

**LNT-05 LANTERNA  
AURA GRANDE**

 cm 40x40, h cm 72

 kg 80

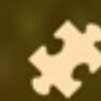
 2 componenti







LNT-06 LANTERNA SELENE GRANDE

 cm 30x30, h cm 62

 kg 39

 2 componenti

LNT-07 LANTERNA SELENE PICCOLA

 cm 23x23, h cm 48

 kg 19

 2 componenti

FIR-01 CUBO LIRI GRANDE

cm 50x50, h cm 65

kg 80

FIR-02 CUBO LIRI MEDIO

cm 39x39, h cm 50

kg 40

FIR-03 CUBO LIRI PICCOLO

cm 28x28, h cm 35

kg 15

FIR-04 LECCE GRANDE

cm 60x60, h cm 126

kg 241

FIR-05 LECCE MEDIO

cm 50x50, h cm 96

kg 152

FIR-06 LECCE PICCOLO

cm 45x45, h cm 65

kg 100

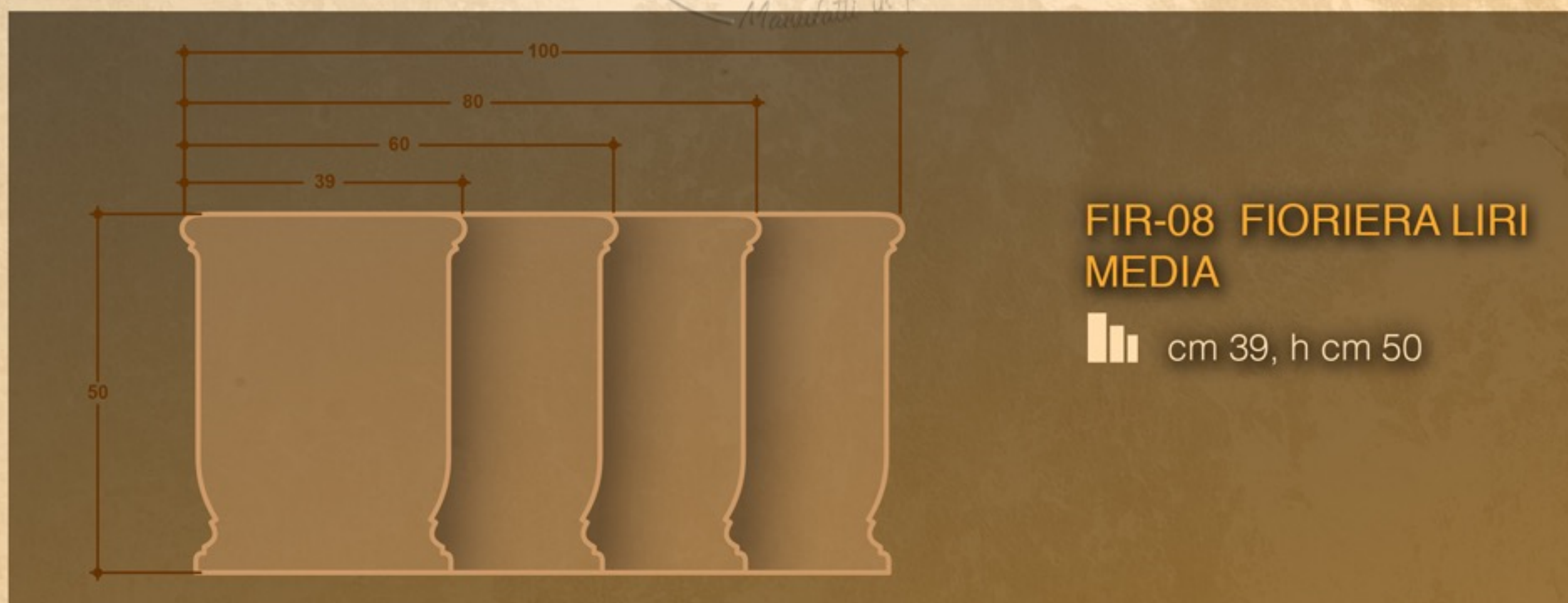
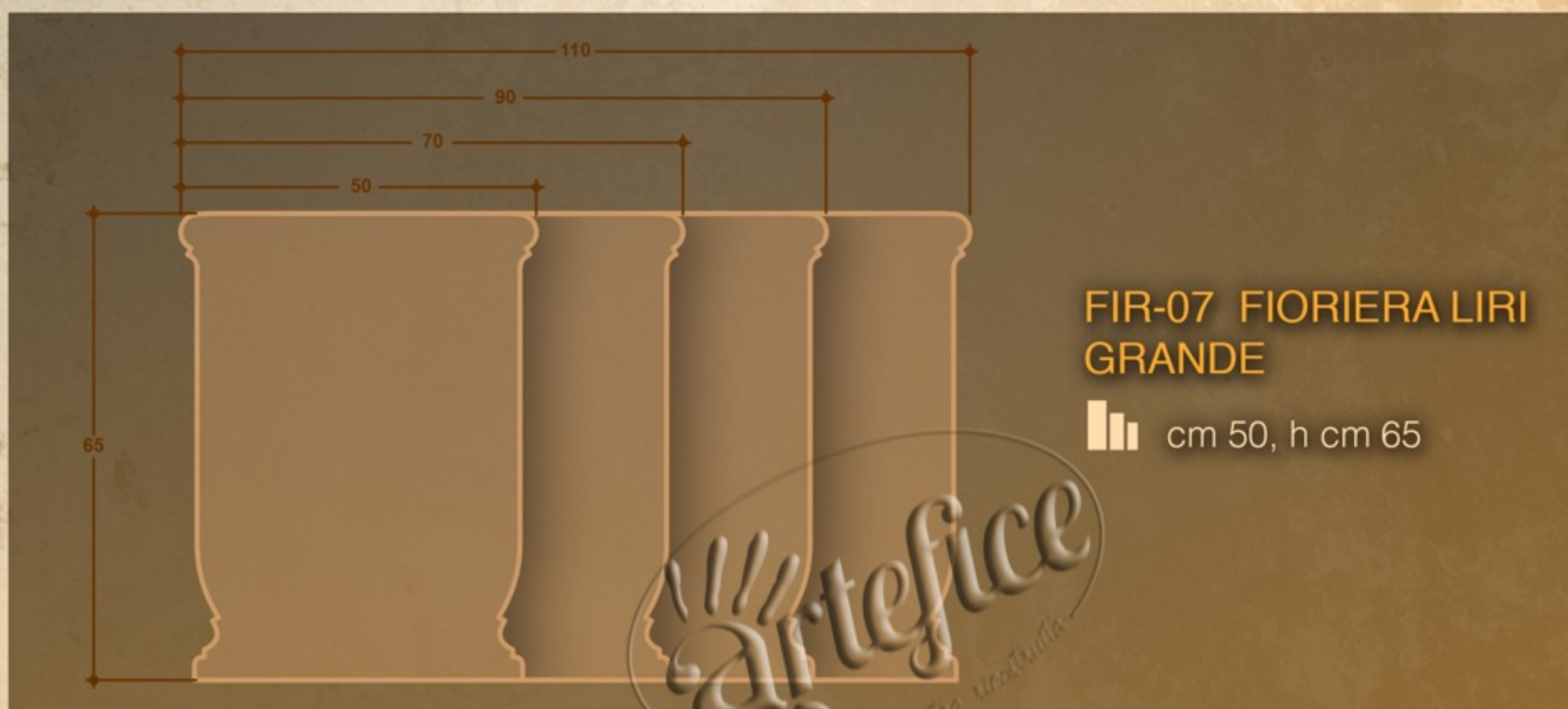

*Collezione Fioriere*

**FIR-10 TORTILE GRANDE**

 cm 43x43, h cm 100

 kg 110

**FIR-11 TORTILE MEDIO**

 cm 37x37, h cm 70

 kg 53

**FIR-12 TORTILE PICCOLO**

 cm 32x32, h cm 50

 kg 42

Artefice

FIR-13 VASO CONO

cm 44x44, h cm 80

kg 70



FIR-14 VASO INTRECCIO

cm 35x35, h cm 70

kg 85



FIR-15 VASO ONDA

cm 45x45, h cm 90

kg 120

Collezione Fioriere



FIR-16 CALICE OMERO

cm 57x57, h cm 76

kg 85



FIR-17 CALICE GRAFFIATO

ø cm 60, h cm 64

kg 94



FIR-18 CALICE ROSE

ø cm 63, h cm 78

kg 115

Artefice

FIR-19 CALICE MOENA

||| ø cm 76, h cm 72

👤 kg 145



FIR-20 CALICE ETRUSCO

||| ø cm 43, h cm 56

👤 kg 50



FIR-21 CALICE OPPIO

||| ø cm 45, h cm 57

👤 kg 36

Collezione Fioriere

FIR-22 VASO MANGIATOIA

 cm 77x55, h cm 40

 kg 100



FIR-23 VASO TUFO

 cm 58x45, h cm 25

 kg 45



FIR-24 VASO ABBEVERATOIO

 cm 100x50, h cm 40

 kg 130





**FIR-25 MORTAIO AUSONIA**

cm 60x45, h cm 20

kg 52



**FIR-27 MORTAIO CORENO**

ø cm 62, h cm 35

kg 55

**FIR-26 CALICE TRAVERTINO**

ø cm 21, h cm 36

kg 15





FIR-28 CINQUECENTO

cm 70x30, h cm 29

kg 56



FIR-29 VASO EDERA

ø cm 30, h cm 20

kg 8



FIR-30 CIGNO

cm 70x41, h cm 57

kg 55

## FIR-31 MORTAIO MURGIA

cm 32x28, h cm 17

kg 19

## FIR-32 MORTAIO TRAVERTINO GRANDE

ø cm 36, h cm 25

kg 14



## FIR-33 MORTAIO TRAVERTINO PICCOLO

ø cm 23, h cm 13

kg 6

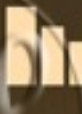

**FIR-33 CIOTOLA componibile**

-  ø cm 100, h cm 120
-  kg 252
-  6 componenti



**FIR-34 CASSETTONE RIGATO**

-  cm 100x40, h cm 58
-  kg 80

### FIR-35 CASSETTA BUCCIATA

 cm 85x35, h cm 42

 kg 75



### FIR-36 CUBO BUCCIATO

 cm 40x40, h cm 45

 kg 50

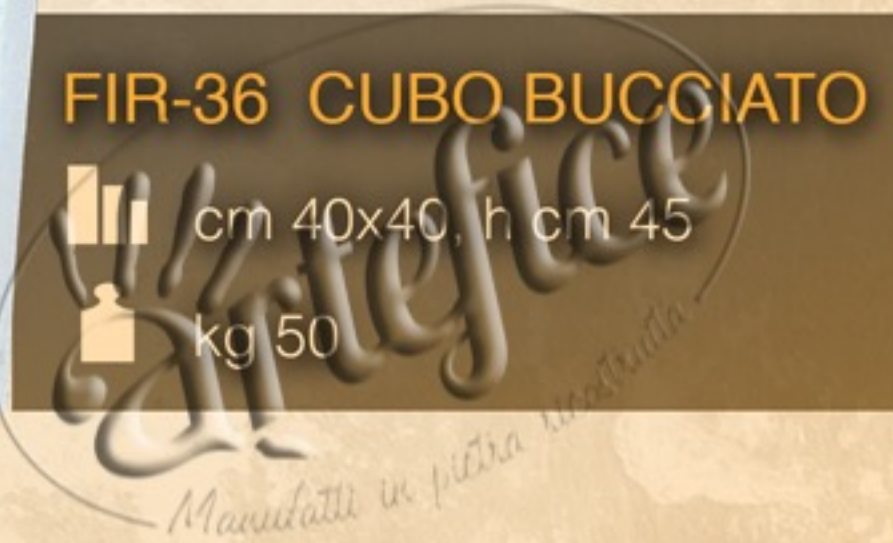

### FIR-37 CASSETTA RIGATA 100

 cm 100x30, h cm 35

 kg 60





### FIR-38 CASSETTA RIGATA 90

 cm 90x30, h cm 35

 kg 55

### FIR-39 CASSETTA RIGATA 80

 cm 80x30, h cm 35

 kg 50

### FIR-40 CASSETTA RIGATA 70

 cm 70x30, h cm 35

 kg 45



# Artefice S.r.l.s

Sede legale: Via Rossini 88, 03043 Cassino (FR) P.Iva 02815040601



Pignataro Interamna (FR) 03040 Superstrada 630 Cassino-Formia Km 7



[www.artefice.net](http://www.artefice.net) - [info.artefice@gmail.com](mailto:info.artefice@gmail.com)



Ufficio 0776 949422 - Michele 339 6969039 - Luca 333 6654357